



Perfect Fit
CLOSETS



CUSTOM CLOSETS

Product Specification & Design Guide

Our Story

At Perfect Fit Closets, our Authorized Dealers are provided with a robust design catalog for all their design and estimation needs. Dealers can quickly design custom closets, pantry, mudroom, office and more with our extensive product offerings and accessories.

With previous professional experience ourselves, as Dealers and Installers, we are all about removing the obstacles involved. Our focus is to streamline processes and provide superior customer service to our partners. We are here to guide you, from your first design to your first installation and all the steps in between. We hope you enjoy working with our products as much as we enjoy offering them to you.

T Table of Contents

Our Story	2
Our Training	4

Closets	5-69
The Benefits	5
Colors	6-9
Profiles	10
Inserts – Glass	11
Drawer Boxes	12
The Build $\frac{3}{4}$ " vs 1- $\frac{1}{2}$ "	13
How the System Works	14-15
Wall Clearances	16
Space Designs Ideas	17-36
Part Specifications	37-46
Tower, Wall & Island Ideas	47-63
Closet Accessories	64-65
Office Accessories	66
Handles	67
Lighting	68-69

Garages	70-90
The Benefits	71
Colors	72-75
How the System Works	76-77
Tall, Base & Upper Cabinets	78-80
Part Specifications	81-84
Profiles	85
Drawer Boxes	86
Space Designs Ideas	87-89
Garage Accessories	90

Design & Install Information	91
Order Process	92
Pallet & Packaging	93
Product Care	94
Warranty	95

Our Training

ONE

Dealer Portal Tour
&
Product Overview

1 Hour
Instructor-led



TWO

Sales - Industry
Design
Standards

1 Hour
Instructor-led



THREE

2020 PFC Design
Catalog
Introduction

1 Hour
Instructor-led



On-going personalized guidance. Enjoy complimentary one-on-one training sessions with a live agent who will assist you with design reviews, offer suggestions, and provide education.

Access our Dealer Portal e-learning resources 24/7, featuring videos and documentation for your sales, design, and installation team.

COMPLIMENTARY

The Benefits

- ❑ Every order is custom produced for your client with hardware included
- ❑ Adjustability of shelves as clients change their needs and inventory
- ❑ No extra charge for specialty sized items
- ❑ Panels and shelves are available in solid 3/4" & 1.5" thickness
- ❑ Limited lifetime warranty
- ❑ Color Matching 3/4" thick drawer boxes
- ❑ All Panels have TOP, FRONT & BOTTOM edge-banding
- ❑ 5 accessory matching color schemes
- ❑ Direct color matched 1mm edge-banding
- ❑ Edge-banding is produced by a Zero-joint glue process leaving the product with smooth soft to the touch edges
- ❑ Industry known and eco-friendly materials
- ❑ Soft-Close undermount slides and hinges as our standards

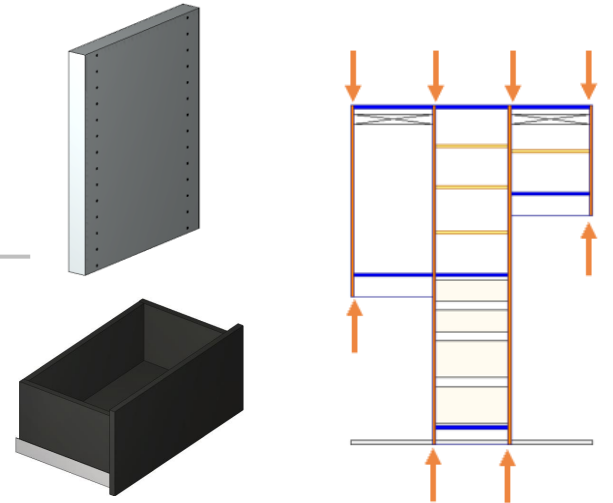

Closets

Mudrooms

Pantry

Laundry

Entertainment

Office

More...



TFL Level One



TFL Level Two

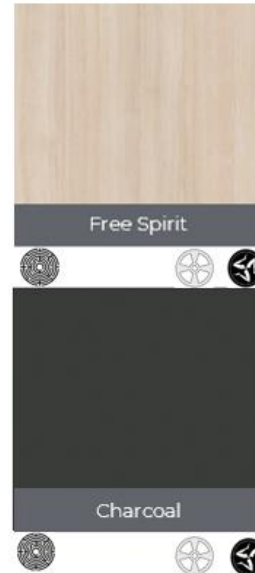

LEGEND:

 1-1/2" Thick

 TFL90 Shaker

 TFL90 Shaker GD

3/4" Drawer Box

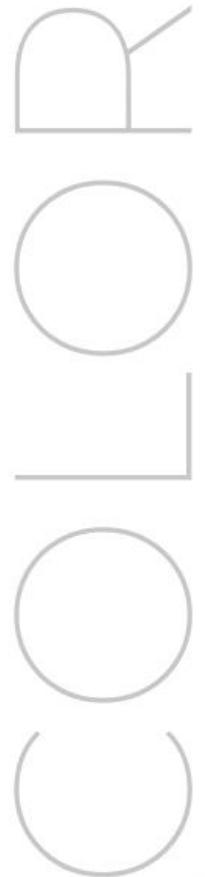

TFL Level Three



Apres Ski

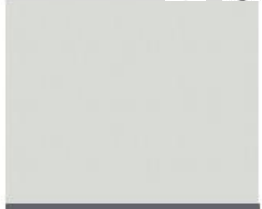
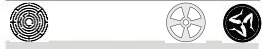

Super Matte Sunset Grey



Cassis

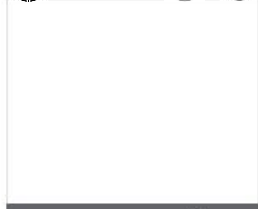

Super Matte White



Esterel

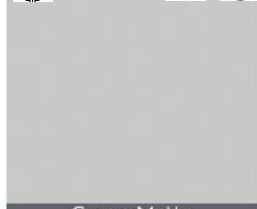

Super Matte Canadian Grey



Silverwood



Winter Fun



LEGEND:

1-1/2" Thick

TFL90 Shaker

TFL90 Shaker GD

3/4" Drawer Box

TFL Level Four



Chiffon

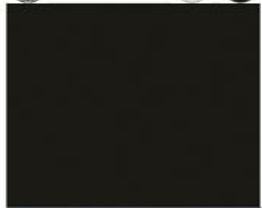

Super Matte Black



Ombre

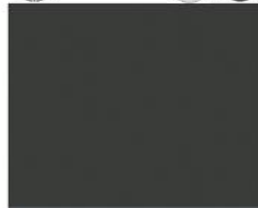

Super Matte Charcoal



Pietra



Super Matte Sage



Rumour

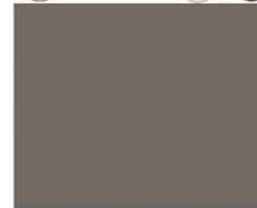

Super Matte Shipshaw



Whisper

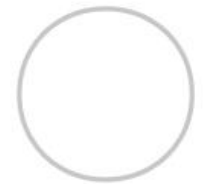

High Gloss

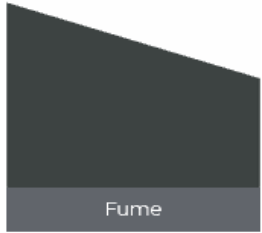
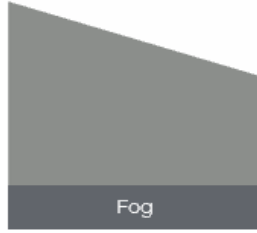
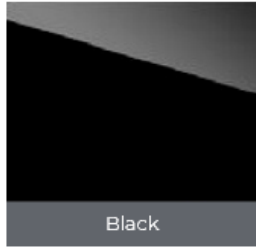
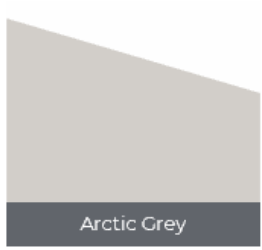

Matte

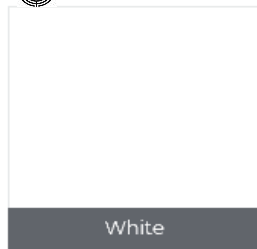
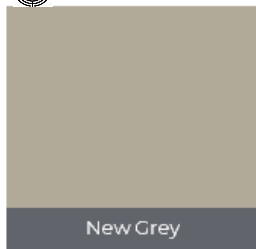
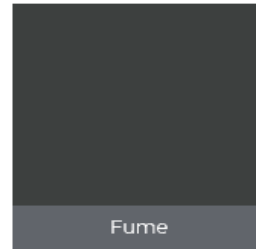
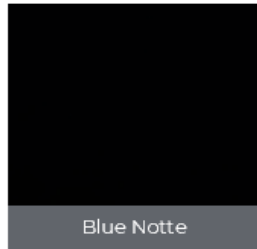
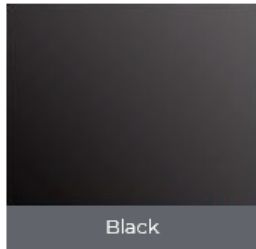

LEGEND:

 1-1/2" Thick

 TFL90 Shaker

 TFL90 Shaker GD

 3/4" Drawer Box



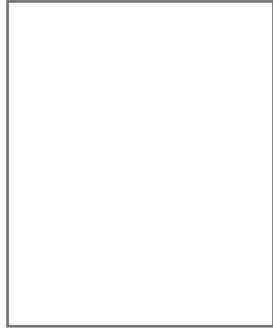

Euro



- 110' Soft-Close Hinges defaulted on all Doors

- 3/4" thick TFL board
- Available in all colors
- Matching 1mm edge-banding
- Max size of 24"W x 96"H per door
- Zero Joint, superior smooth corner edge-banding

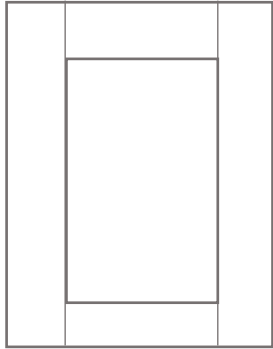

TFL 90 Shaker

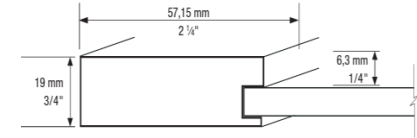

- 3/4" thick TFL board with 1/4" TFL center panel
- 90 degree joint with 2-1/4" stiles and rails
- Available in select colors
- Matching 1mm edge-banding
- Max size of 24"W x 96"H per door
- Zero Joint, superior smooth corner edge-banding

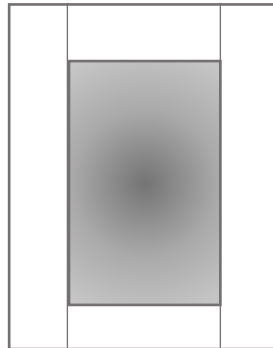

TFL 90 Shaker Glass

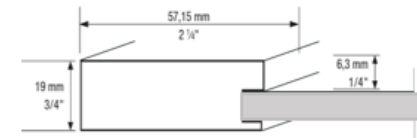

- 3/4" thick TFL board with glass insert
- 90 degree joint with 2-1/4" stiles and rails
- Available in all colors
- Matching 1mm edge-banding
- Max size of 24"W x 96"H per door
- Zero Joint, superior smooth corner edge-banding

SE
TI
RO
AR





■ Bamboo

Elegant elongated textures to create a semi transparent view

Gorgeous translucent frosted textures

Frosted ■



■ Cathedral

Woven textures showcasing a translucent finish

Trending rippled effects providing an exquisite look

Fluted ■



■ Clear

Classic see through glass

Timeless mirror finish

Mirror ■



inserts



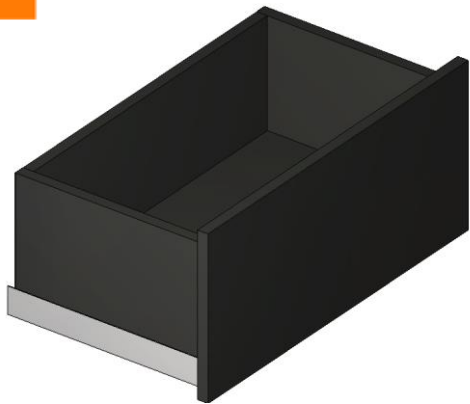

25 plus TFL Colors

- ❑ TFL drawer boxes are available in all matching TFL colors to the designed closet.
- ❑ Soft-close or Push-to-Open slides are used with every drawer box.
- ❑ DTC's concealed undermount Slides featuring Soft-Close, full extension and a 4-way adjustment locking clips.



TFL Drawer Box

3/4" Thick Walls & 3/4" Thick Bottom
 Undermount Soft-close Slides
 Push to Open Slides available
 1 1/4" Spacers available for install behind doors



Custom Width Range: 8" to 36"

Standard Widths: 18" / 24" / 30"

Standard Heights: 6" / 8" / 9" / 12"

Standard Depths: 12" / 14" / 16" / 18" / 22"

Dovetail Drawer Box

5/8" Thick Walls & 1/4" Thick Bottom
 Undermount Soft-close Slides
 Push to Open Slides available
 1 1/4" Spacers available for install behind doors



Custom Width Range: 8" to 36"

Standard Widths : 18" / 24" / 30"

Standard Heights: 6" / 8" / 9" / 12"

Standard Depths: 12" / 14" / 16" / 18" / 22"

Scooped Dovetail Drawer Box

5/8" Thick Walls & 1/4" Thick Bottom
 Undermount Soft-close Slides
 Push to Open Slides available
 1 1/4" Spacers available for install behind doors



Custom Width Range: 8" to 36"

Standard Widths : 18" / 24" / 30"

Standard Heights: 2" / 3" / 6" / 8"

Standard Depths : 12-5/8" / 14-5/8" / 16-5/8"

Depths Continued : 18-5/8" / 22-5/8"

DRAWERS

The Build $\frac{3}{4}$ " vs $1\frac{1}{2}$ "

Enhance your closet design using $1\frac{1}{2}$ " thick parts to provide a bold look to your next project.

Construction: Two solid $\frac{3}{4}$ " panels doweled and glued together with one seamless 1mm edge band, All parts selected will have the same drilling pattern as the $\frac{3}{4}$ " parts.



VS



$\frac{3}{4}$ " Thick

Available in TFL / Matte / High Gloss
Available in Shelves, Panels and Tops
Matching 1mm Edge-banding

1-1/2" Thick

Available in TFL or Matte (High Gloss not available)
Available in Shelves, Panels and Tops
Matching 1mm Edge banding

Not Available: Wall Panels, Matte Colors & Radius
Corner shelves.

The System

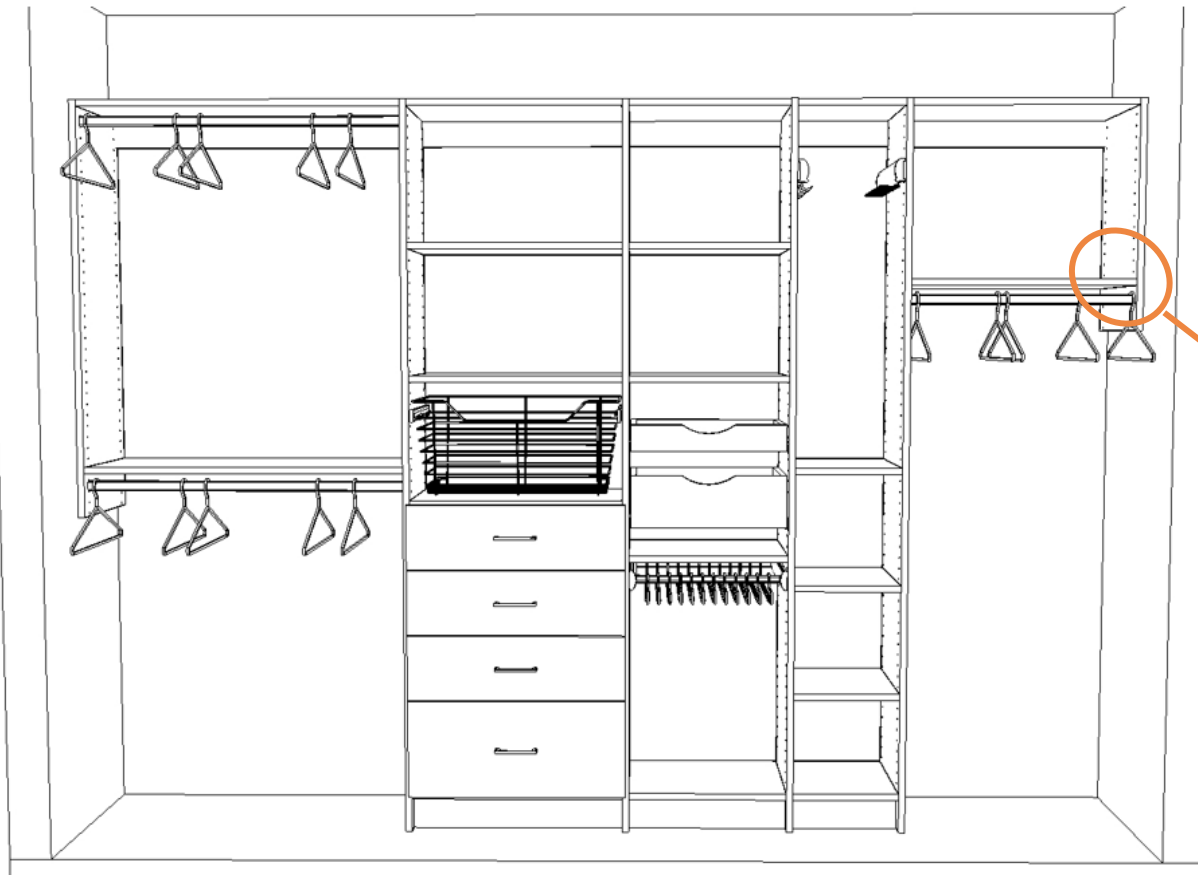

Flush Rail Cam H.263.50.705 'Cam System for Fixed Shelves. 4 Cams per Fixed Shelf. Screw onto single or double bolt system



System Bolt Single H.262.20.985 'Single bolt for Fixed Shelves. Cam system Locks onto this Bolt. Place on end Gables/Panels



System Bolt Double H.263.24.973 '1 Place bolt for Fixed Shelves. Cam system Locks onto this Bolt. Place on middle Gables/Panels that have another fixed shelf on the other side

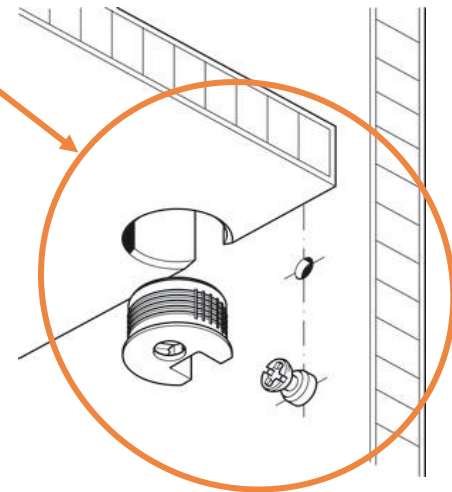

- Assembly of all systems start with the connectors and hardware's for each component. All parts connect too and follow the 32mm line boring system holes making adjustability quick and easy as storage requirements change.

The Wall System

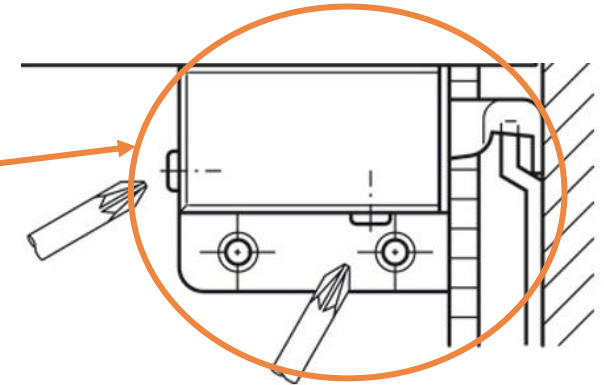
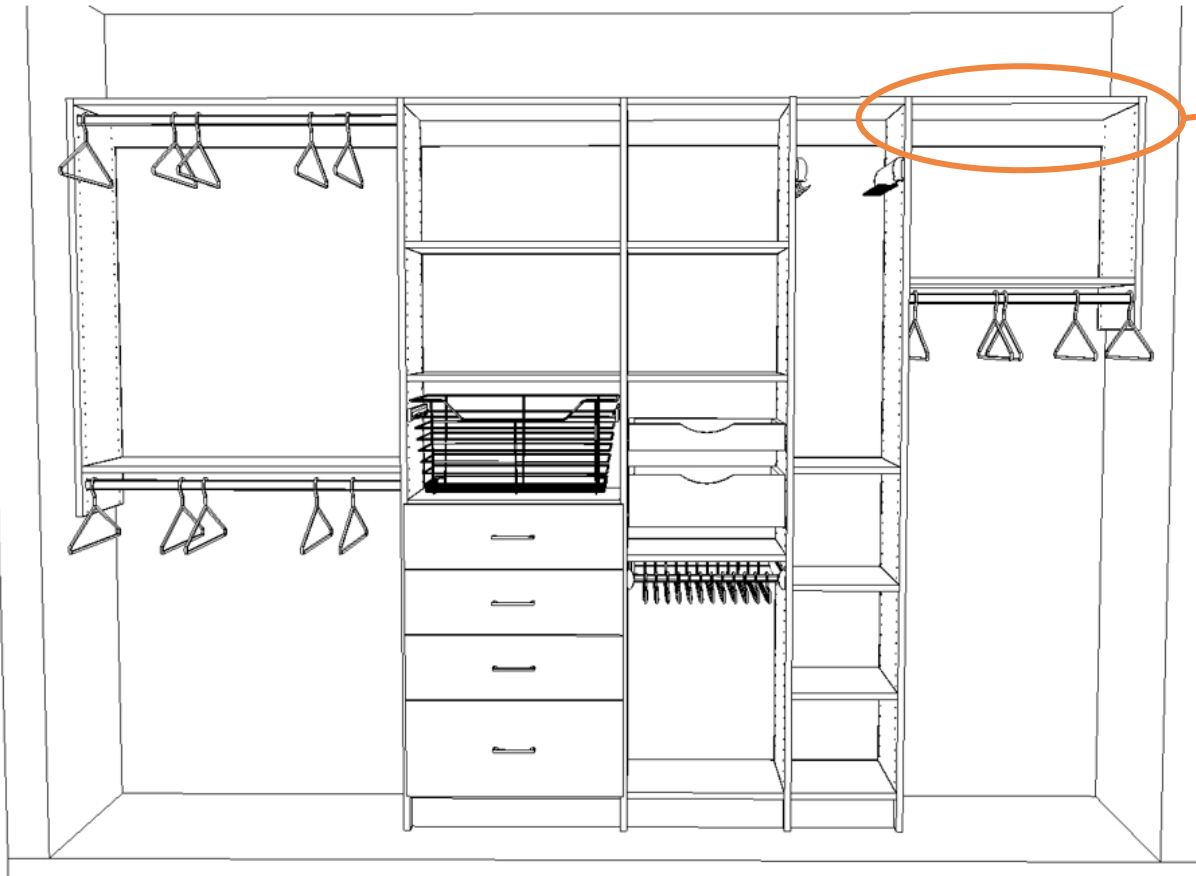

White / Black / Brown / Beige

Hanging Hardware

- Our hanging systems have 2 way adjustability's which compensates for bowed or uneven walls, whilst giving superior stability and support. Covers for rail and hardware come in 4 complimentary colors.

Wall Clearance

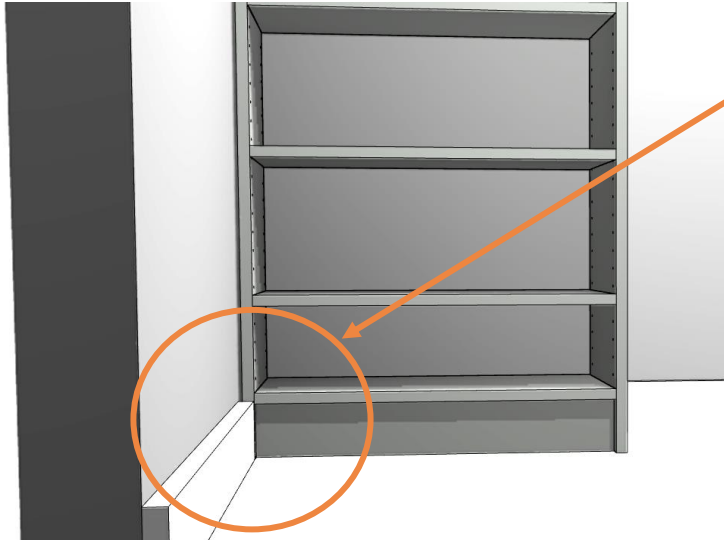

Modules with NO Drawers or Doors:

Designing with modules against a wall must include a minimum clearance of 1/4" on both ends of the design.



Modules WITH Drawers or Doors:

If the module is to have Drawers or Doors, then a minimum clearance of 1" to 1.5" is needed to allow for opening. Standard 3" filler is added to the design.



Reach-In

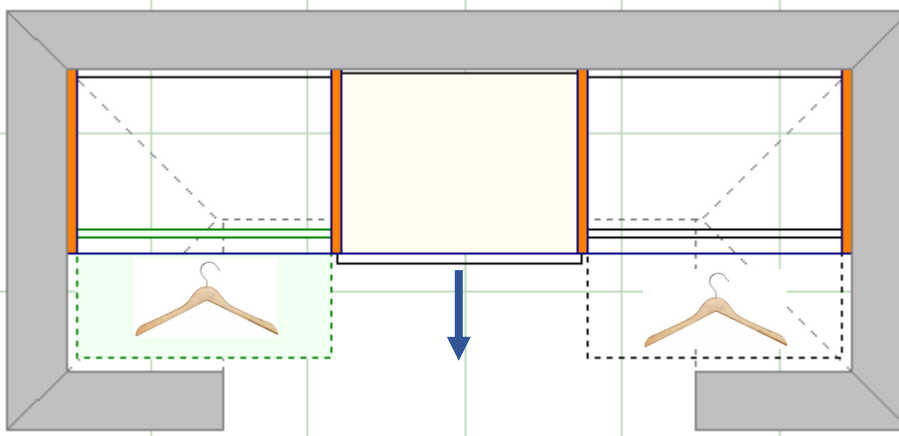

- With a variety of design configurations, the standard concept is derived using a 3 module system (hang/storage/hang) due to restriction of front return walls. This space is typically a single design wall.

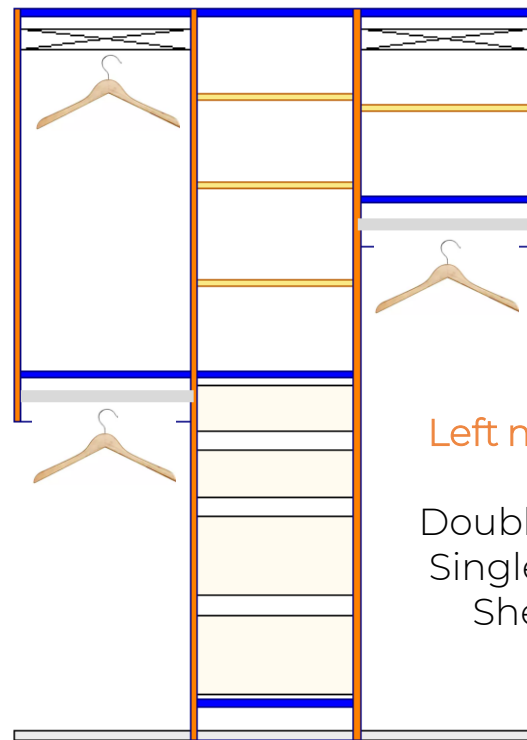

Left module:
Double Hang
Single Hang
Shelves

Middle module:
Shelves
Drawers/Shelves
Double Hang
Single Hang/Shelves
Single Hang/Drawers
Accessory/Shelves

Right module:
Double Hang
Single Hang
Shelves



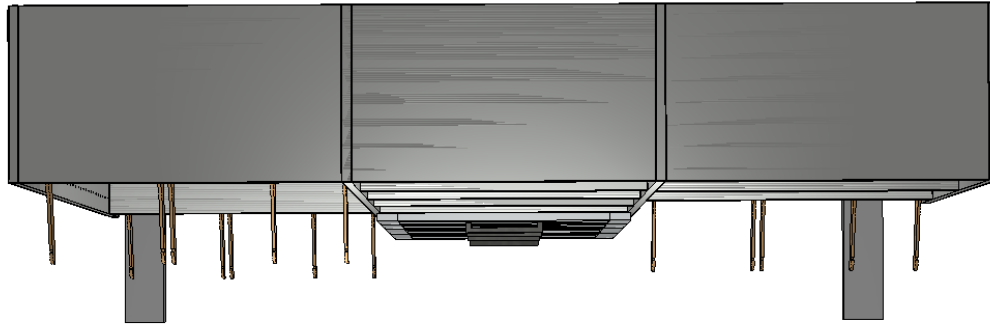

Industry Design Standards:
Depth 14"
Height 84"

Rod Placement:
Long Hang 65"
Double Hang 40" & 80"

Notes:
Design modules with min. ¼"
spacing from Left and Right
walls to ensure maximum fit
without cutting.



Reach-In



Primary - WIC

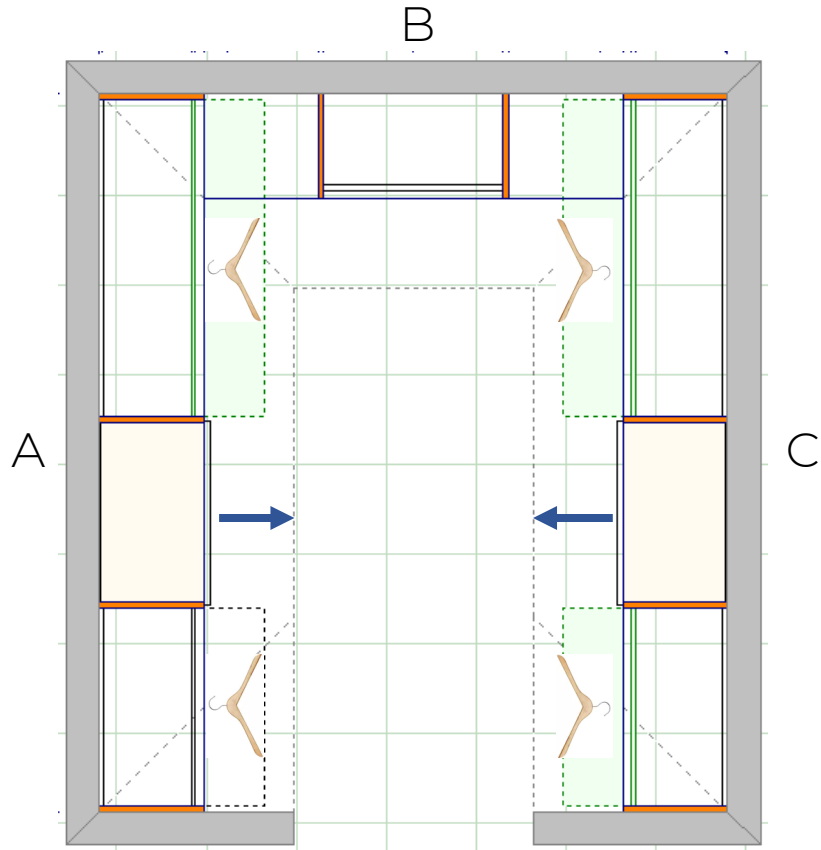

Primary Walk-in Closets are a multi-design wall layout. Keep design symmetry for an organized appealing result.

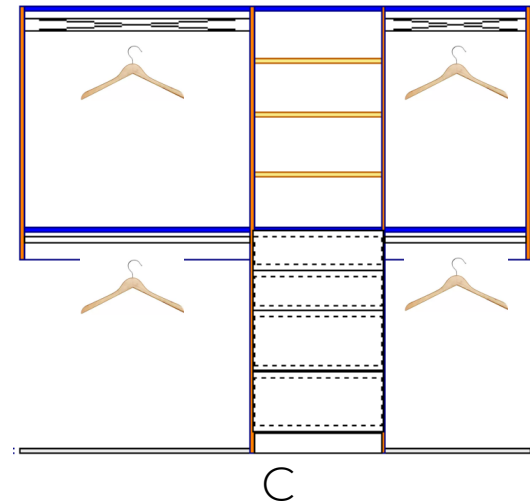
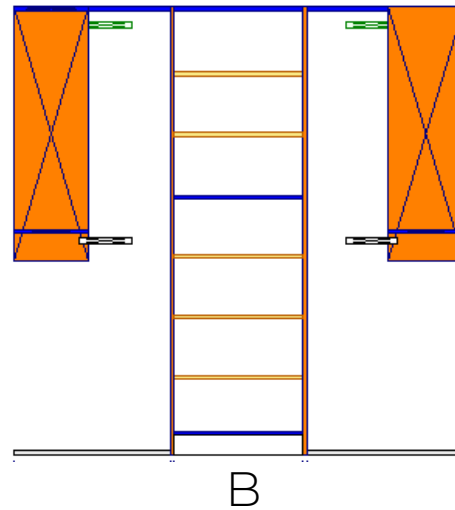
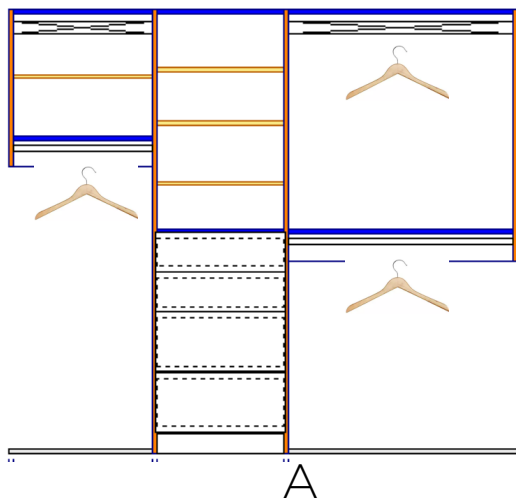

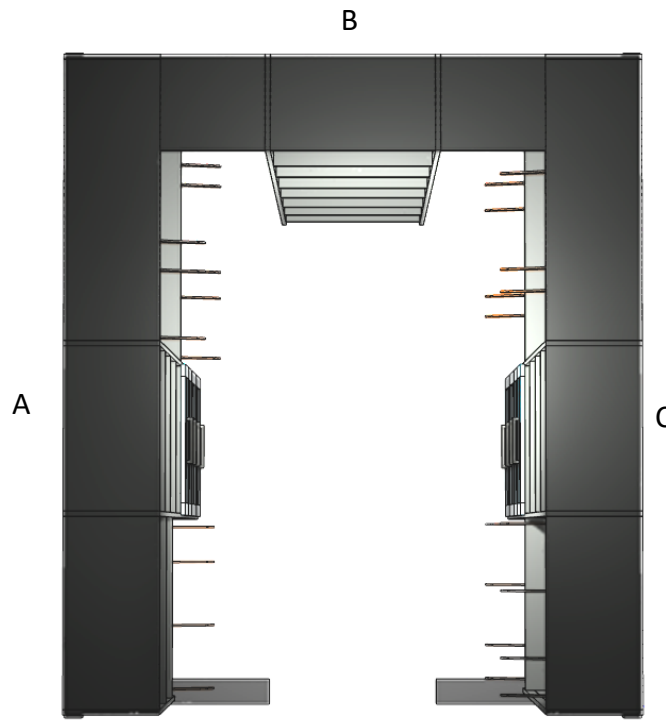

Industry Design Standards:
Depth 14"
Height 84" – 1" below ceiling

Rod Placement:
Long Hang 65"
Double Hang 40" & 80"

Notes:
28" spacing recommended when starting the next design wall. Measured from previous design wall, not the panels.

Start build minimum 1" from wall and add filler if using drawers or doors next to the wall, if not applicable then design 1/4" from the Left and Right walls.



A



B

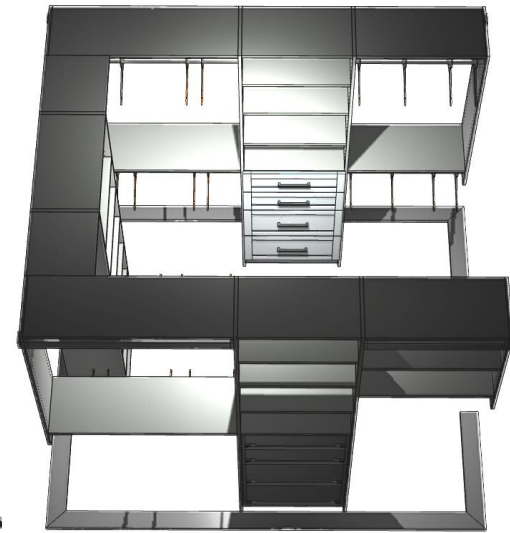

C



Wardrobe

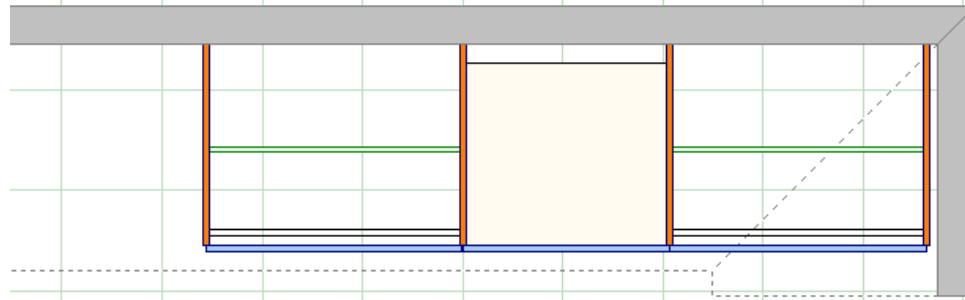

- Is your closet not big enough? Or, your space doesn't have a designated closet? Design a 24" deep wardrobe unit by using a variety of widths and components to achieve the perfect closet for your needs.

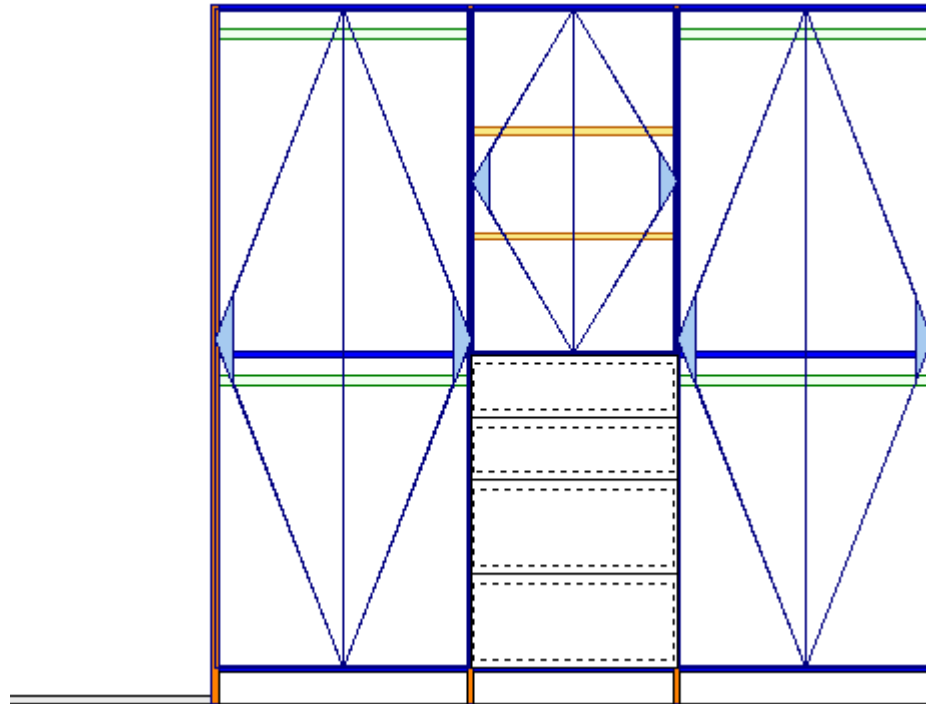

wardrobe



▣ Industry Design Standards:
Depth 24"
Height 84" – 1" below ceiling

▣ Rod Placement:
Long Hang 65"
Double Hang 40" & 80"

▣ Notes:
Start build minimum 1" from wall
and add filler if using drawers or
doors next to the wall.



Pantry

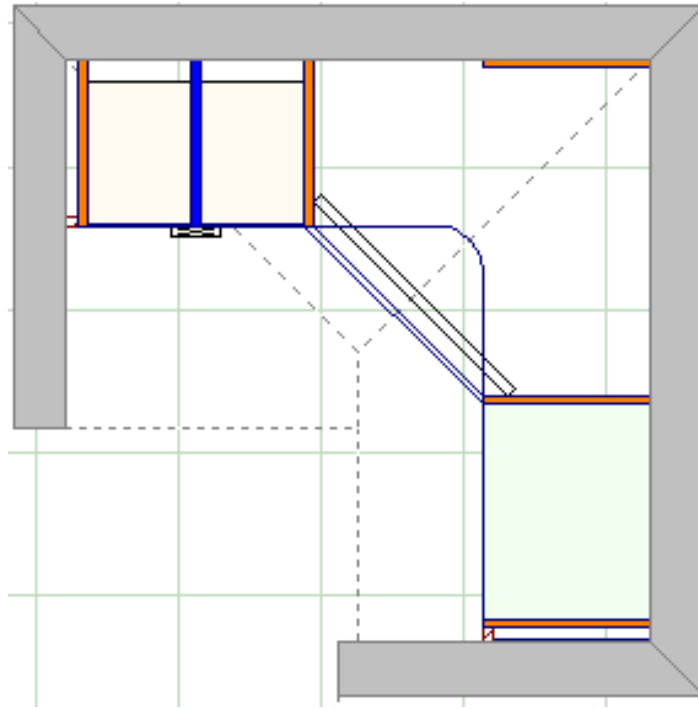
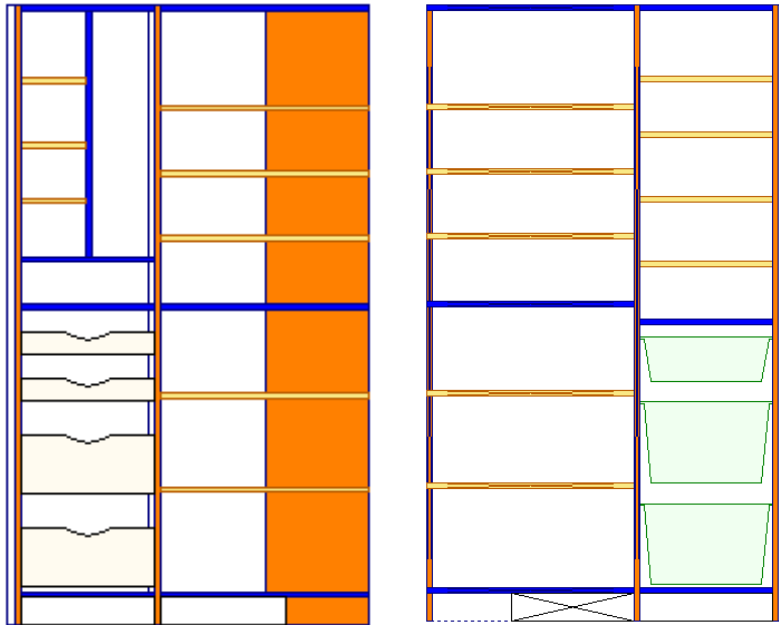

- Using scooped dovetail boxes, wire baskets, along with corner shelving towers, will maximize the storage capacity resulting optimal organization and functionality.

Pantry

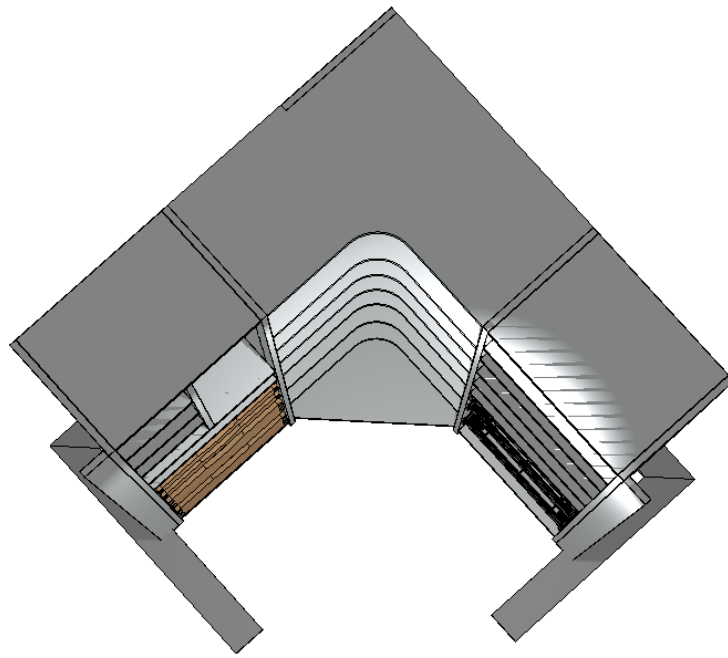

□ Industry Design Standards:
Depth 15" - 16"
Height 84" - 1" below ceiling

□ Notes:
Start build minimum 1" from wall
and add filler if using drawers or
doors next to the wall.

Recommended to use floor panels
inside a pantry, versus wall panels,
due to weight of pantry products.



Linen Closet

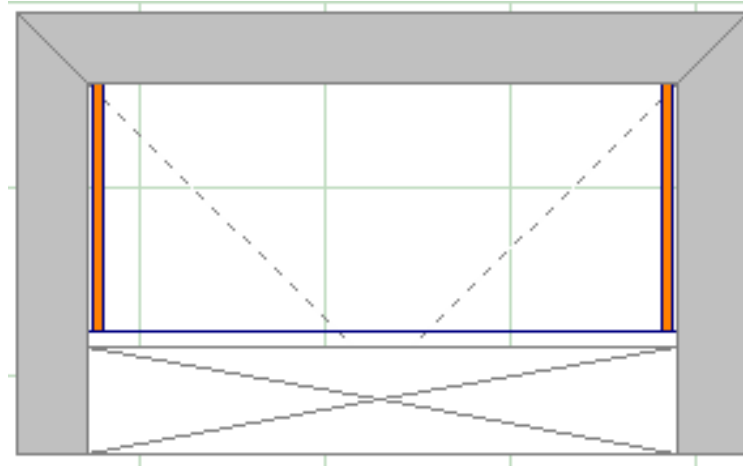

- Creating the unit short and deep allows for best horizontal storage while still giving access for bulkier items at the top.

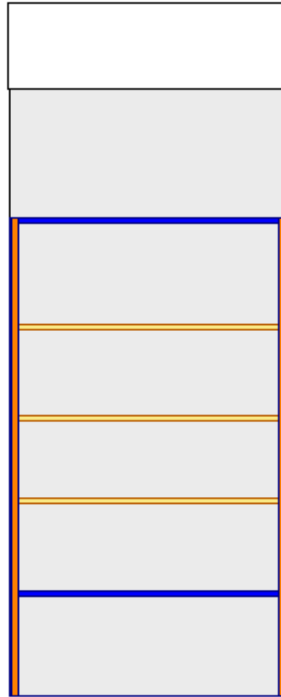

Linen Closet

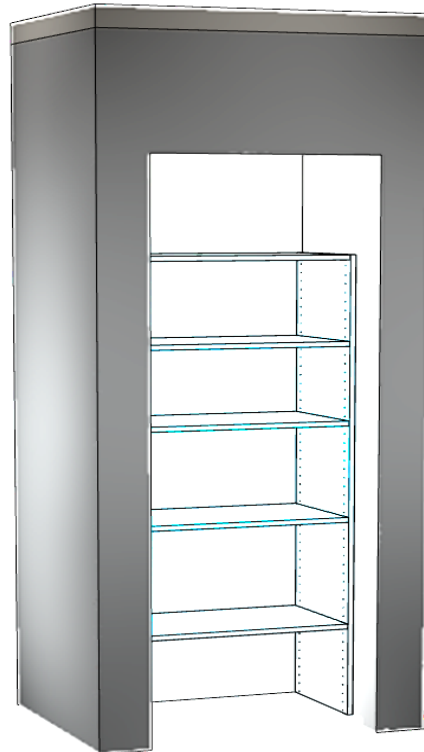
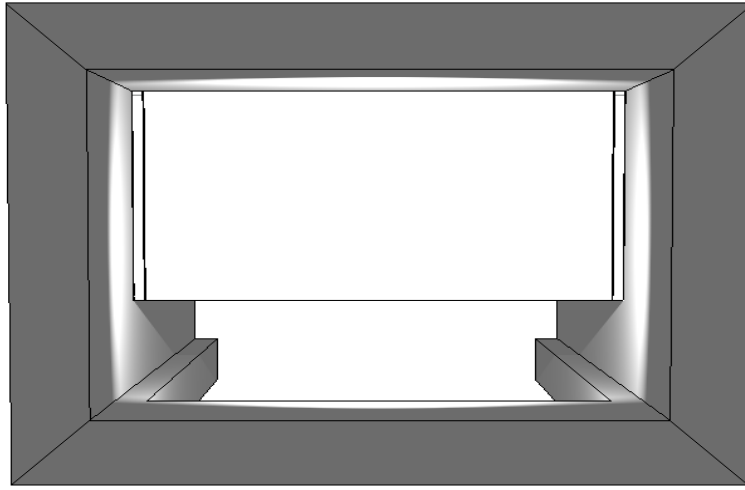

□ Industry Design Standards:

Depth 19"
Height 72"

□ Notes:

Design modules with min. ¼" spacing from Left and Right walls to ensure maximum fit without cutting.



Kids Closet

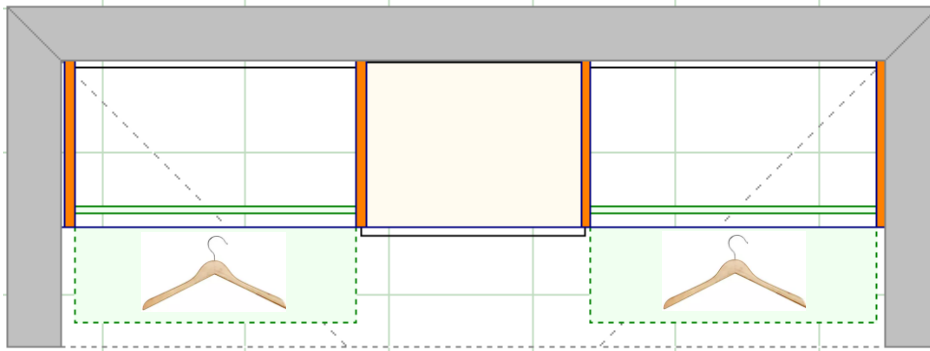

- Utilizing the triple rod system allows adjustability as the child gets older and their inventory and needs change.

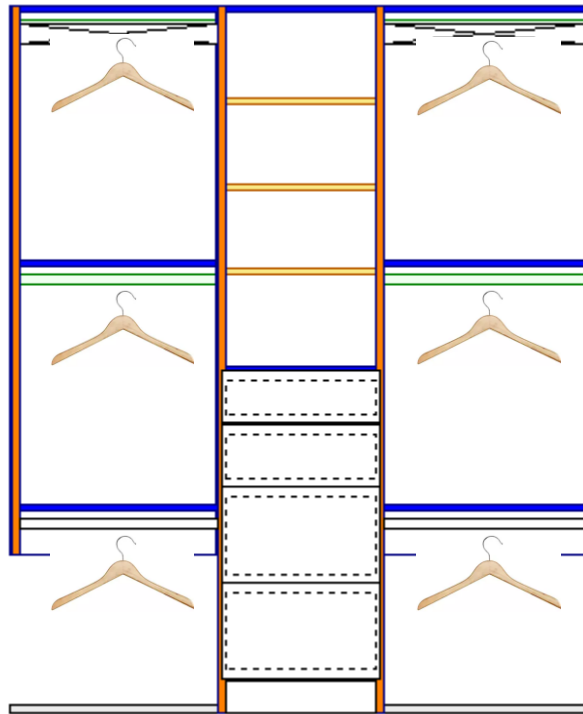

Kids Closet

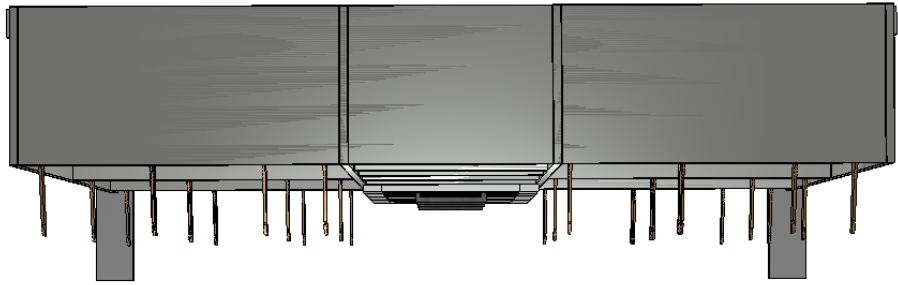

Industry Design Standards:
Depth 14"
Height 84"

Rod Placement:
Triple Hang 25" / 53" / 80"

Notes:
Design modules with min. 1/4"
spacing from Left and Right
walls to ensure maximum fit
without cutting



Mudroom

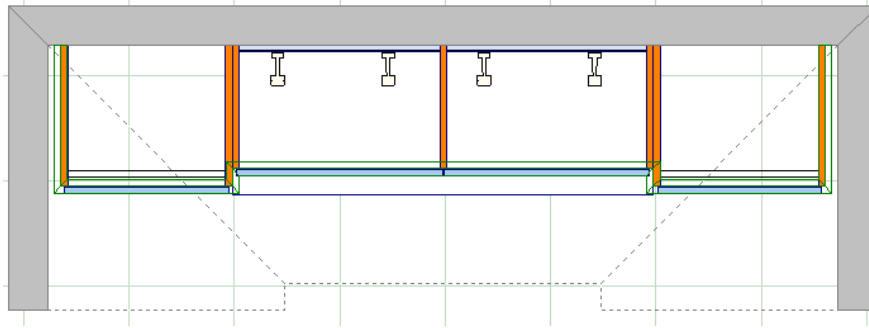

- Having a functional but esthetically appealing mudroom, allows this ergonomically designed space to be used daily by all family members.

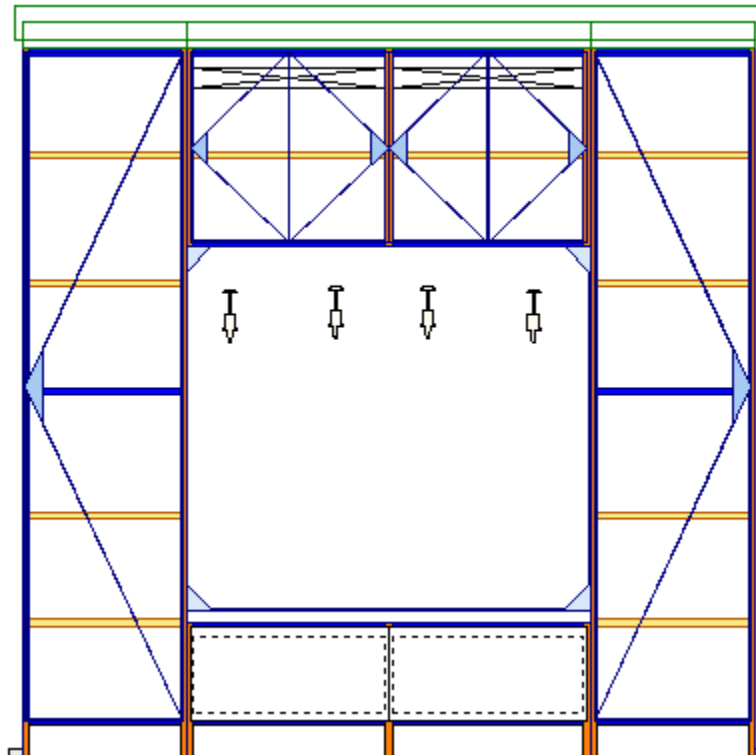



- **Industry Design Standards:**
 - Bench Depth 19" to 24"
 - Bench Height 18"
 - Upper Cabinet Depth 14" to 19"
 - Tall Cabinet Depth 19" to 24"
 - System Height 84" – 1" below ceiling

- **Notes:**
 - Start Cabinet min. 1" from wall and add filler if using drawers or doors next to the wall.

Recommended to place hook placement 48" above the bench.

Mudroom



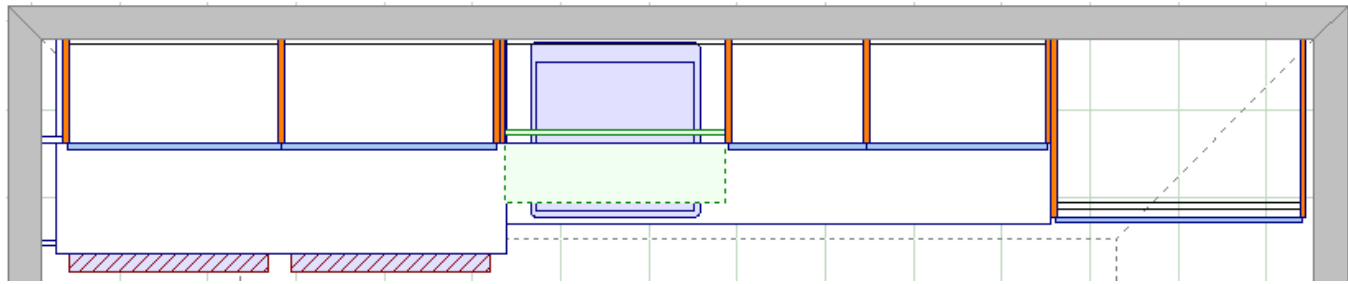

- ❑ Messy laundry room is a thing of the past. With a functional design, an area to hang dry clothes and a counter top to fold items, you are sure to fall in love with this space once again.

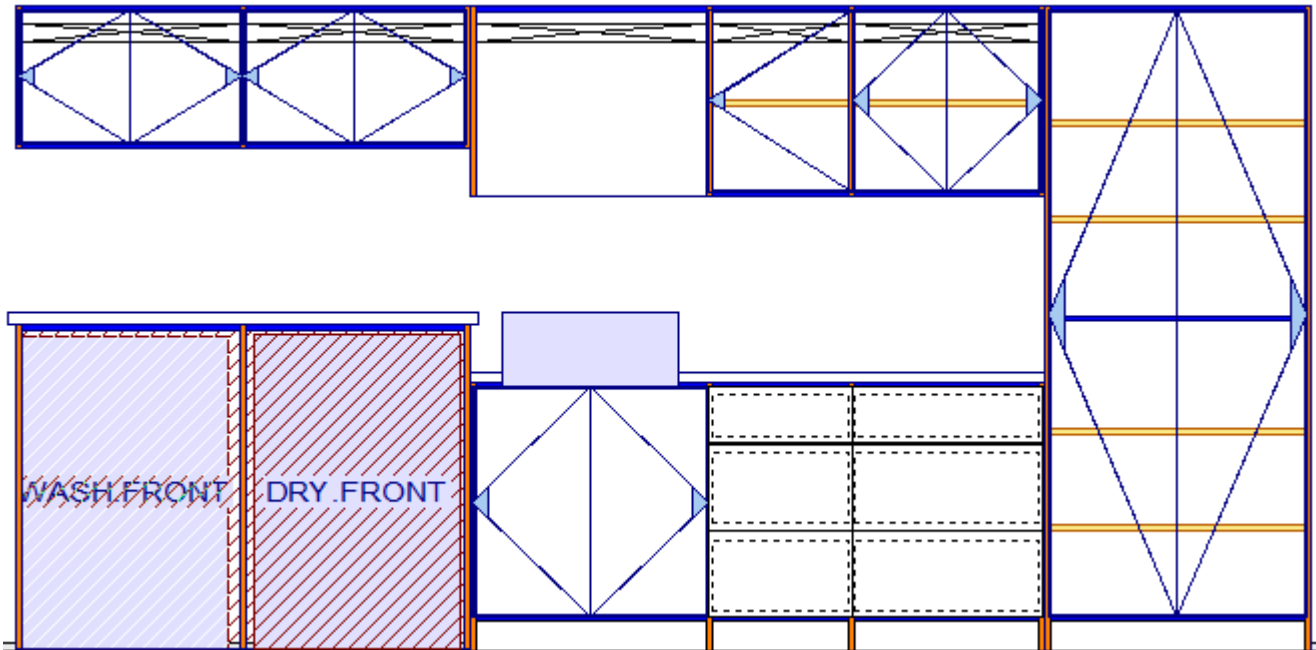



Industry Design Standards:

- Base Cabinet Depth 24"
- Base Cabinet Height 36"
- Space between Counter and Uppers min. 18"
- Upper Cabinet Depth 14" to 19"
- Tall Cabinet Depth 24"
- System Height 84" – 1" below ceiling

Notes:

Start Cabinet min. 1" from wall and add filler if using drawers or doors next to the wall.



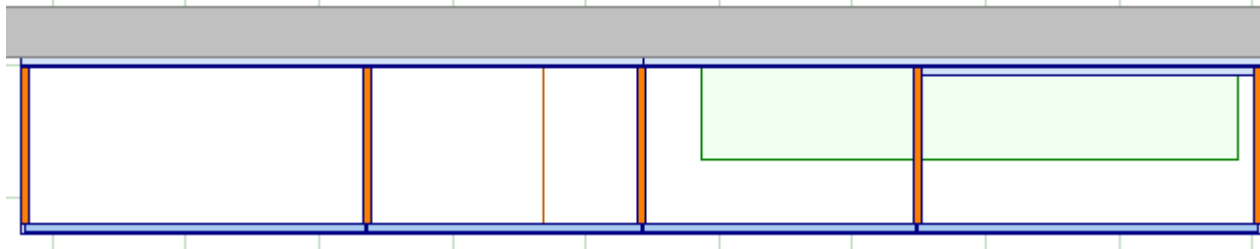

- Kick back and spend your evening watching your favorite shows in amongst an elegantly designed entertainment system with push to open drawers and vertical lift doors. Design with any color and or grain textures to fit your space

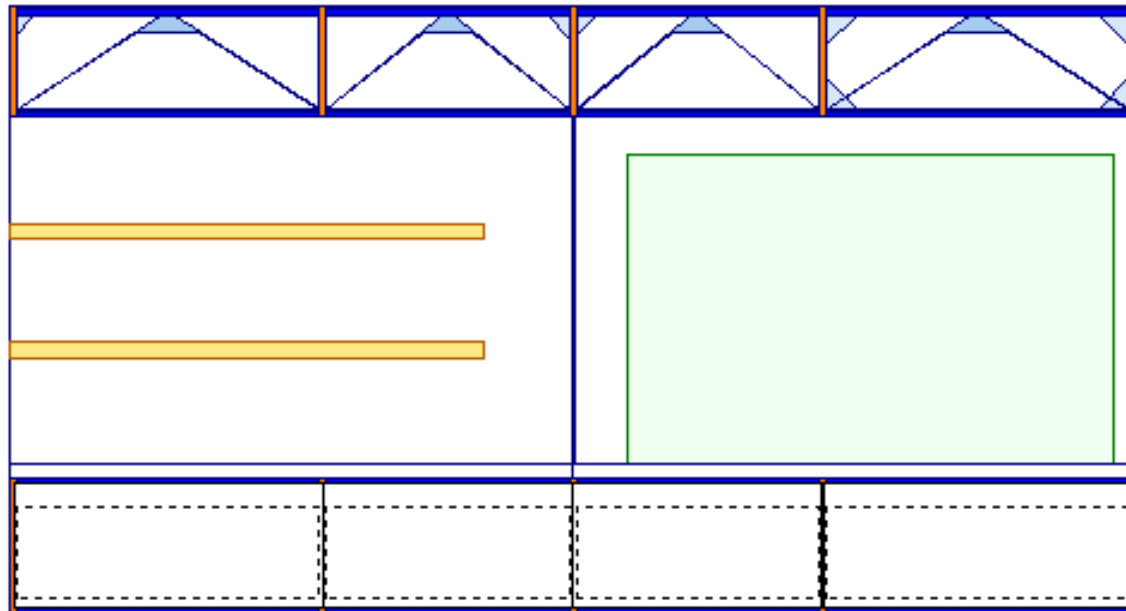

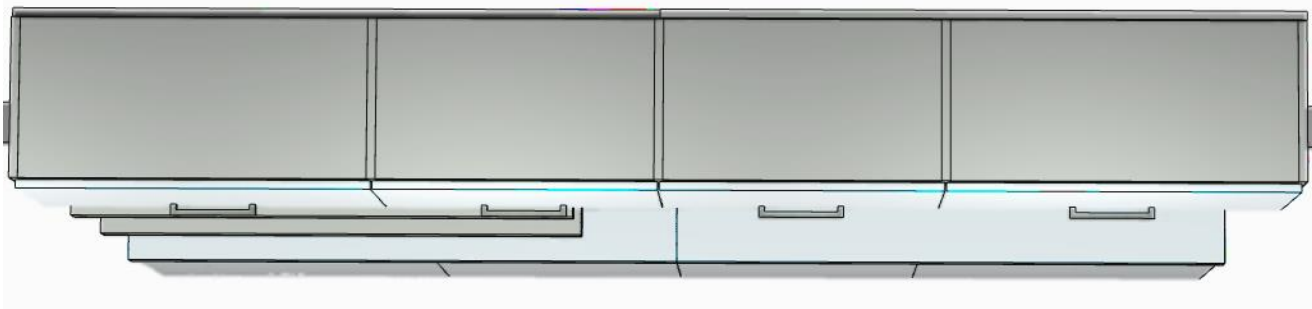

- **Industry Design Standards:**
Base Cabinet Depth 16" to 19"
Base Cabinet Height 18"
Upper Cabinet Depth 12" to 14"
System Height – design dependent

- **Notes:**
Place Back Panels behind the cabinets to allow proper anchoring.

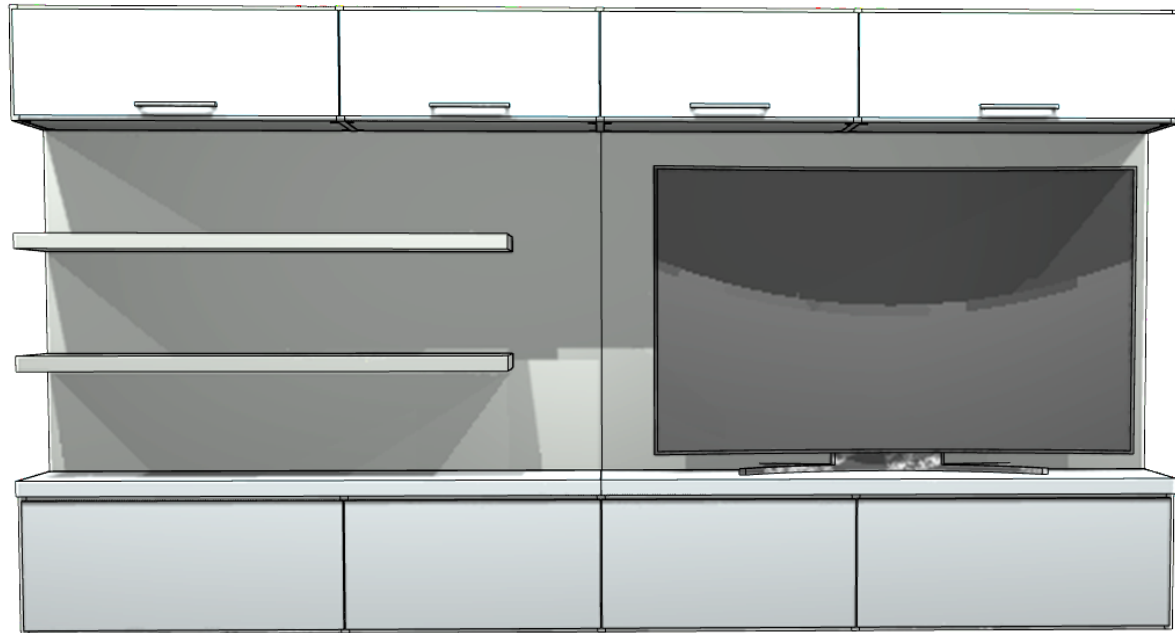

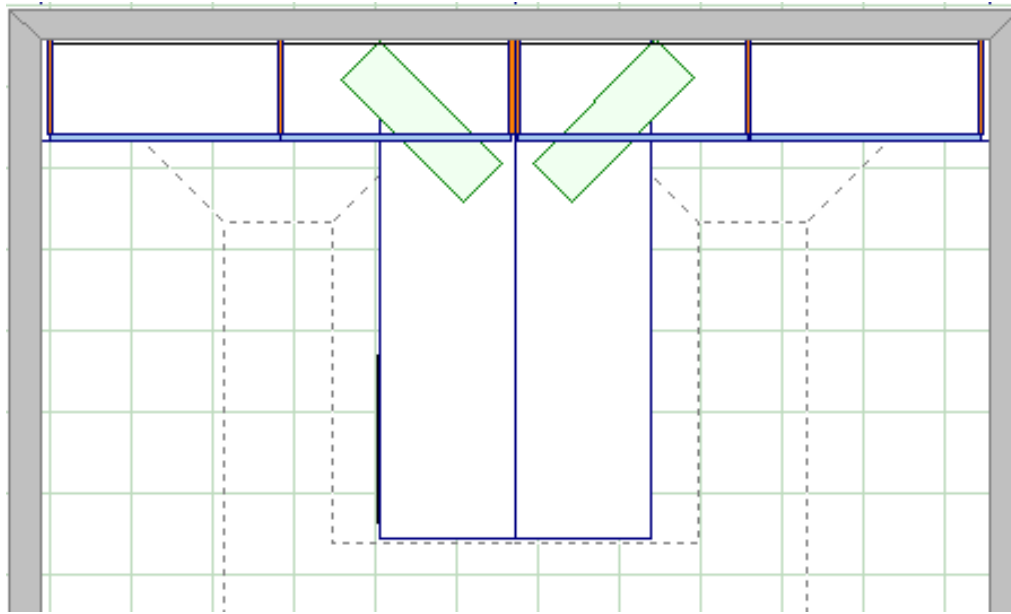

- Design a single or double work station utilizing office storage accessories and monitor mounts to give the desk top a clean and organized look.

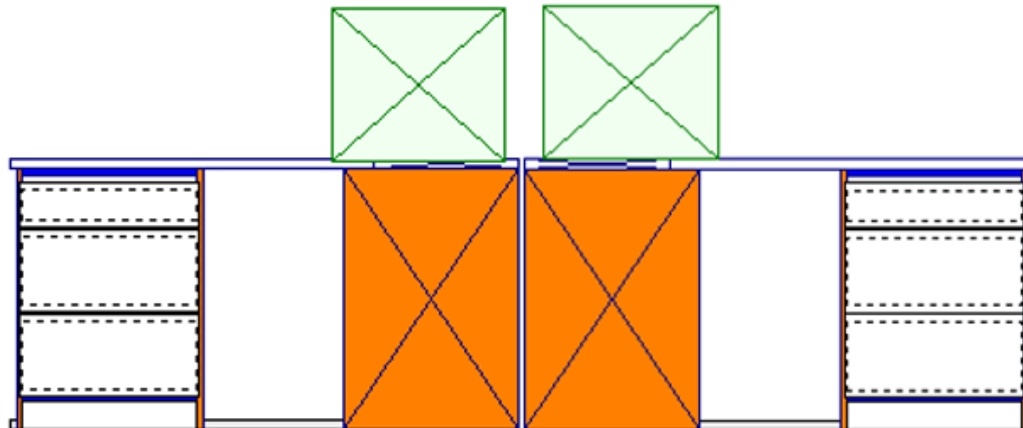
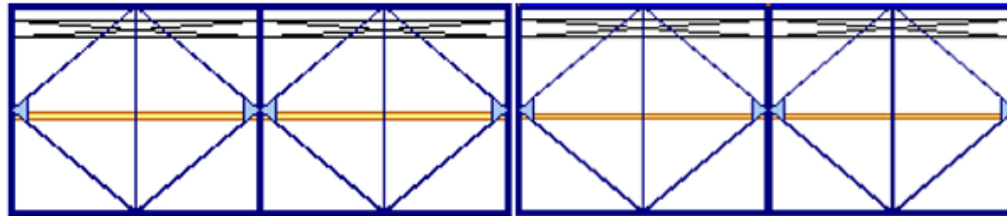

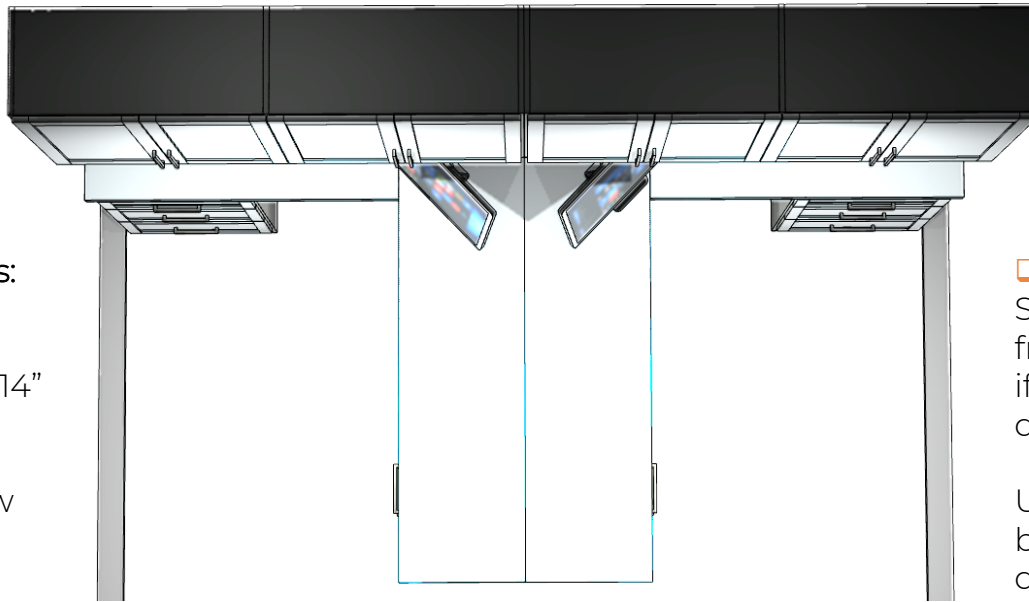

Industry Design Standards:
Desk Depth 19" to 24"
Desk Height 29" to 30"
Upper Cabinet Depth 12" to 14"
Space between desk and
Uppers min. 18"
System Height 84" – 1" below
ceiling

Notes:
Start build minimum 1"
from wall and add filler
if using drawers or
doors next to the wall.

Use 12.5" height drawer
boxes for filing cabinet
drawers.

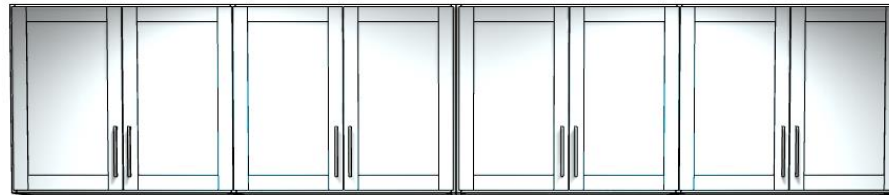

office



Part Specs

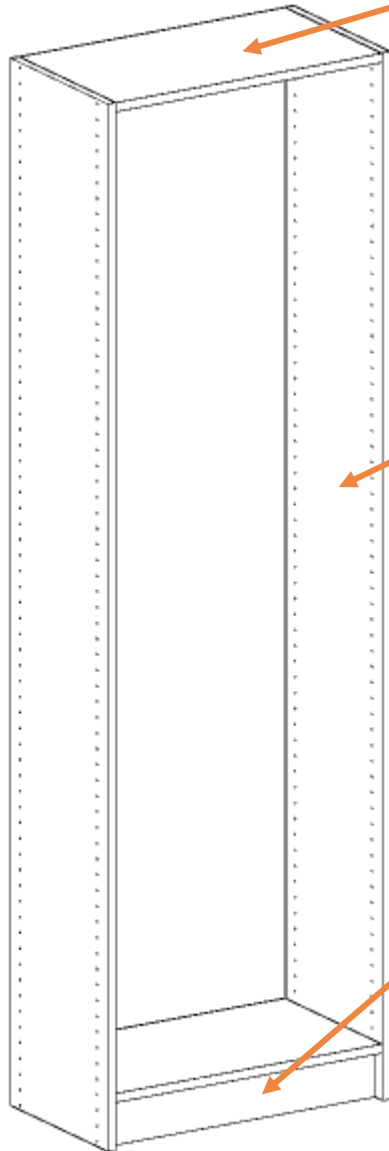

Shelves

Custom Width Range: 4" to 48"
Standard Widths: 18" / 24" / 30" / 36"

Custom Depth Range: 8" to 30"
Standard Depths: 14" / 16" / 19" / 24"

Thickness Availability: 3/4" or 1-1/2"

Floor Panels

Custom Height Range: 6" to 108"
Standard Heights: 84" / 96" / 108"

Custom Depth Range: 8" to 30"
Standard Depths: 14" / 16" / 19" / 24"

Thickness Availability: 3/4" or 1-1/2"

Toe Kicks

Standard Heights: 3-13/16" / 5" / 6-5/16"
Standard Height: 3-13/16"

Custom Width Range: 4" to 48"
Standard Widths: 18" / 24" / 30" / 36"

Thickness Availability: 3/4"

- Default edge-banding locations apply to individual parts.
- Parts can be custom sized at no extra charge.



Part Specs

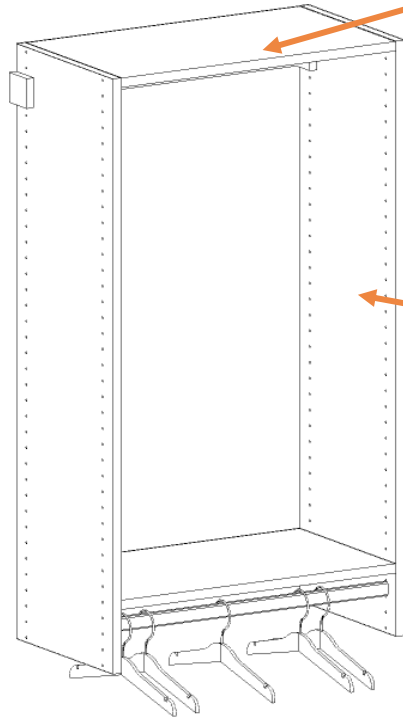

Shelves – Fixed with Cams

Custom Width Range Width: 4" to 48"
Standard Widths: 18" / 24" / 30" / 36"

Custom Depth Range: 8" to 30"
Standard Depths: 14" / 16" / 19" / 24"

Thickness: ¾" or 1-½"

Wall Panels

Custom Height Range: 12" to 84"
Standard Heights: 34" / 48" / 84"

Custom Depth Range: 8" to 15"
Standard Depth: 14"

Thickness: ¾" (1 ½" not available)

Shelves – Adjustable

Custom Width Range: 4" to 96"
Standard Widths: 18" / 24" / 30" / 36"

Custom Depth Range: 8" to 30"
Standard Depths: 14" / 16" / 19" / 24"

Thickness: ¾" or 1-½"

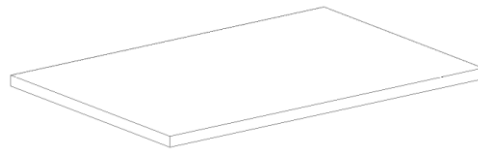

- Default edge-banding locations apply to individual parts.
- Parts can be custom sized at no extra charge.



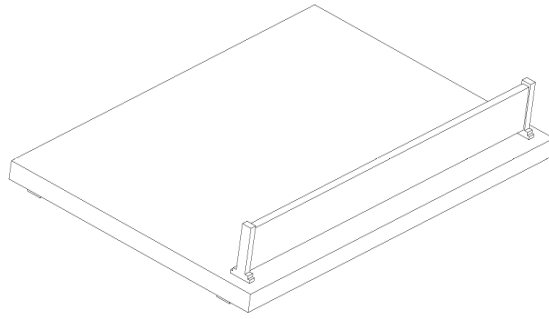

Angled Shoe Shelves with Fence

Custom Width Range: 8" to 37"
Standard Widths: 18" / 24" / 30" / 36"

Custom Depth Range: 14" to 30"
Standard Depths: 14" / 16" / 19" / 24"

Thickness: 3/4" or 1-1/2"

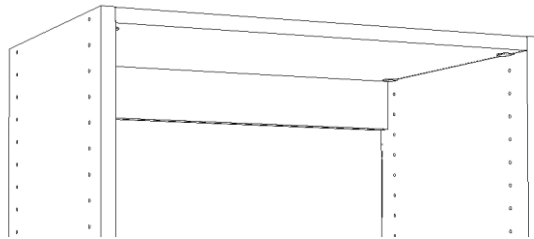

Cleats

Custom Width Range: 6" to 48"
Standard Widths: 18" / 24" / 30" / 36"

Height: 3"

Thickness: 3/4"

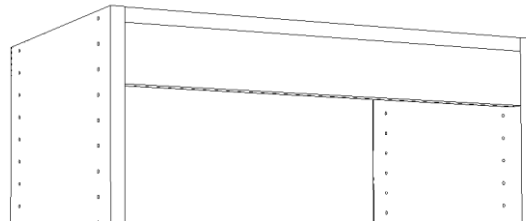

Valance

Custom Width Range: 6" to 48"
Standard Widths: 18" / 24" / 30" / 36"

Height: 3"

Thickness: 3/4"

- Default edge-banding locations apply to individual parts.
- Parts can be custom sized at no extra charge.



Part Specs

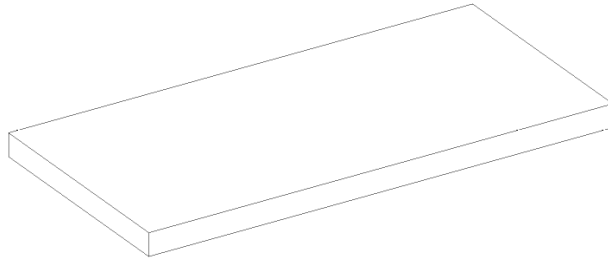
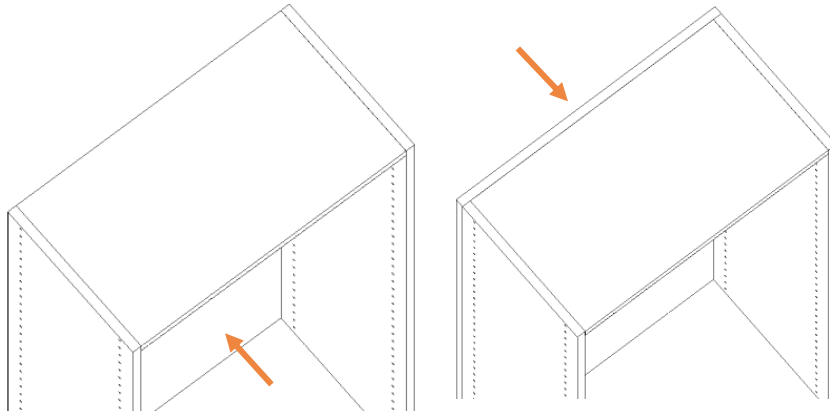

Backs or Applied Backs

Custom Width Range: 6" to 48"
Standard Widths: 18" / 24" / 30" / 36"

Custom Height Range: 6" to 108"

Thickness: 3/4"

Tops

Custom Width Range: 6" to 96"

Custom Depth Range: 6" to 48"

Thickness: 3/4" or 1-1/2"

Filler

Custom Width Range: 3" to 10"
Standard Width: 3"

Custom Height Range: 6" to 108"

Thickness: 3/4"

- Default edge-banding locations apply to individual parts.
- Parts can be custom sized at no extra charge.



Part Specs

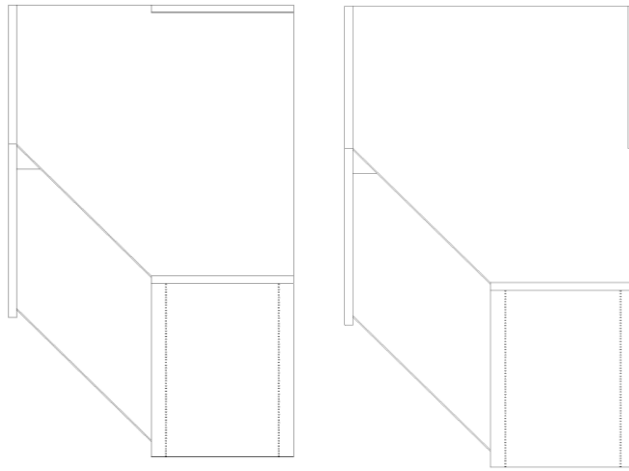

Angled Corner Shelves (Left or Right)

Custom Width Range: 24" to 48"
Standard Width: 28"

Custom Depth Range: 8" to 30"
Standard Depth: 14"

Thickness: 3/4" or 1-1/2"

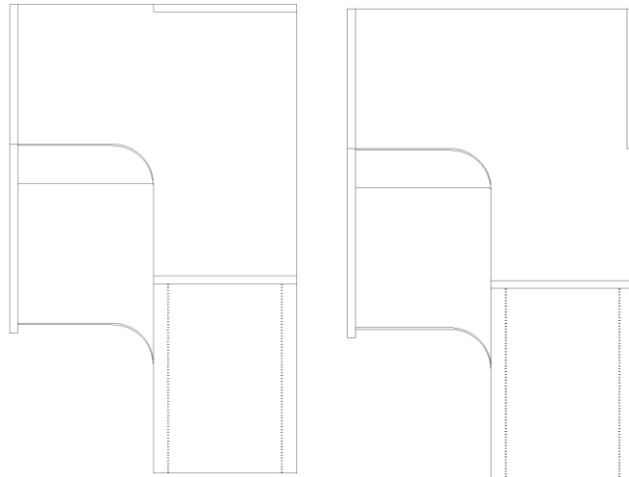

Radius Corner Shelves (Left or Right)

Custom Width Range: 24" to 48"
Standard Width: 28"

Custom Depth Range: 8" to 30"
Standard Depth: 14"

Thickness: 3/4"

Note: Not available in Matte or High Gloss

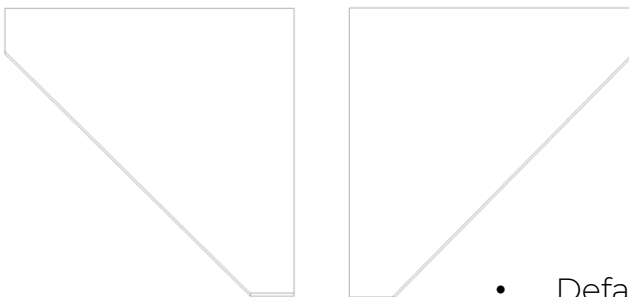

Outside Corner Shelves (Left or Right)

Custom Width Range: 8" to 24"
Standard Width: 14"

Custom Depth Range: 8" to 24"
Standard Depth: 14"

Thickness: 3/4" or 1-1/2"

- Default edge-banding locations apply to individual parts.
- Parts can be custom sized at no extra charge.



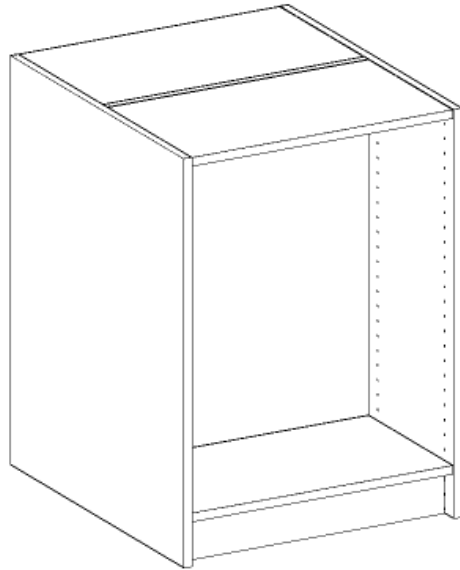

□ Islands

Custom Width Range: 4" to 48"

Standard Widths: 18" / 24" / 30" / 36"

Custom Depth Range: 24 3/4" to 43 3/4"

Standard Depths: 14"/14" // 16"/16" // 19"/19" // 19"/24"

Mix & Match Depths: 14"/16" // 14"/19" Etc.

Note: 24"/24" Not available

Thickness: 3/4" or 1-1/2"

Islands consist of the following parts:

- Island Panels
- Back Panel
- Fixed Shelves
- Toe Kicks

Add additional parts for your custom designed Island

Notes:

The Back Panel slides between the fixed shelves to create the H structure.

Multiple Island modules can be connected together.

- Default edge-banding locations apply to individual parts.
- Parts can be custom sized at no extra charge.



parts

DOORS

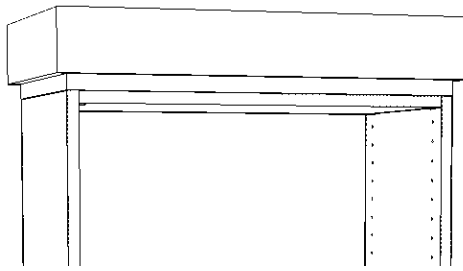

FRONT Molding (2pc)

Standard Height: 3" Back Piece
Standard Heights: 4" / 5" / 6" Front Piece
Length Offered: 96"

2 piece system - Typically mounted against the ceiling or provide a finished stepped look .

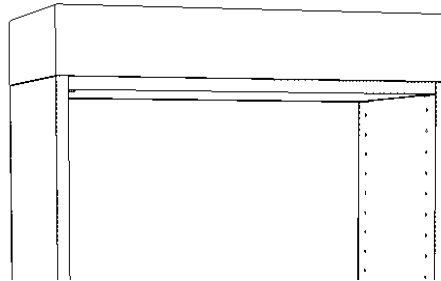

TOP Molding (1pc)

Standard Heights: 4" / 5" / 6" Front Piece
Length Offered: 96"

1 piece system- Provide a taller grand finish or used to scribe against the ceiling.

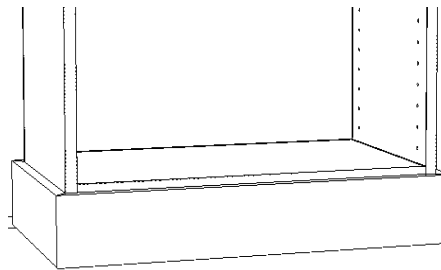

TOE Molding (1pc)

Standard Heights: 4" / 5" / 6" Front Piece
Length Offered: 96"

1 piece system - Used with 3 different size toe kicks in conjunction with Doors or Drawers or by itself.

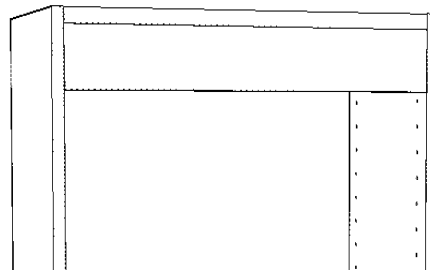

VALANCE Molding (1pc)

Standard Height: 3"
Length Offered: 96"

1 piece system - Used below a shelf to create a large fascia look and or used to hide lighting for a table top area

- All moldings provided in 96" lengths that will be cut-to-fit on-site during install.
- All 2 piece moldings to the ceiling REQUIRE minimum 5" of height space.





□ Door Profiles – (Euro / Shaker / Shaker GD)

Custom Width Range: 8" to 48"

Standard Widths: 18 5/8" / 24 5/8" / 30 5/8" / 36 5/8"

Custom Height Range: 12" to 96"

Thickness: 3/4"

Note: Single door maximum width of 24 5/8"

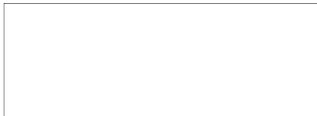

□ Lift Door Profiles – (Euro / Shaker / Shaker GD)

Custom Width Range: 22" to 48"

Standard Widths: 24 5/8" / 30 5/8" / 36 5/8"

Custom Height Range: 9" to 15"

Thickness: 3/4"

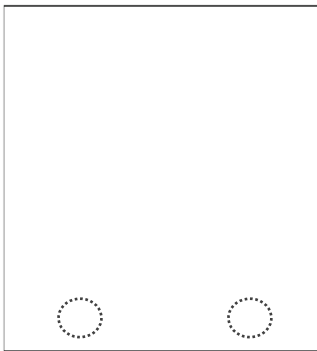

□ Hamper Door - (Euro / Shaker / Shaker GD-not available)

Custom Width Range: 18" to 30"

Standard Widths: 18 5/8" / 24 5/8" / 30 5/8"

Standard Height: 27 5/8" only

Thickness: 3/4"

- Default edge-banding locations apply to individual parts.
- Parts can be custom sized at no extra charge.



Part Specs



❑ Drawers - (Euro / Shaker / Shaker GD-not available)

Custom Width Range: 8" to 36"

Standard Widths: 18 5/8" / 24 5/8" / 30 5/8" / 36 5/8"

Profile Standard Heights: 6" / 8" / 9" / 12"

Actual Size: 6 = 6 1/8" // 8 = 7 7/16" // 9 = 8 11/16" // 12 = 11 1/4"

Thickness: 3/4"

❑ Jewelry / Belt / Ironing Drawer - (Euro / Shaker / Shaker GD-not available)

Standard Opening Width: 24" only

Standard Profile Width: 24 5/8"

Standard Heights: 6" / 8"

Thickness: 3/4"

- Default edge-banding locations apply to individual parts.
- Parts can be custom sized at no extra charge.



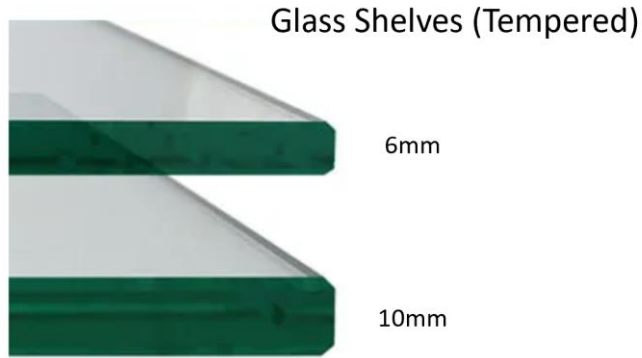

□ Tempered Glass Shelves

Custom Width Range: 6" to 48"
Standard Widths: 18" / 24" / 30" / 36"

Custom Depth Range: 8" to 30"
Standard Depths: 14" / 16" / 19" / 24"

Thickness: 6mm or 10mm

Notes:

Polished edges all around with a slight chamfer.

Recommend to design with 10mm for any possible weighted applications



□ Floating Shelf

Custom Width Range: 24" - 78"

Custom Depth Range: 7" - 12"
Standard Depth: 12"

Thickness: 1-1/2"

Note:

Includes cut-to-size wall rail and needed hardware.

Concealed brackets are adjustable to angle shelf from the wall.



Towers - Hanging Shelves

Shelving / Hanging Tower

8" - 30" Depth
6" - 107" Height
4" - 48" Width
Overall Hanging Depth 22"
37" Min. Hanging Height Space

Double Hanging Tower

8" - 30" Depth
6" - 107" Height
4" - 48" Width
Overall Hanging Depth 22"
Require Min. 84" Height Tower

Triple Hanging Tower (KIDS)

8" - 30" Depth
6" - 107" Height
4" - 48" Width
Overall Hanging Depth 22"
26" Hanging Height Space

Shelving Tower

4" - 48" Width
8" - 30" Depth
6" - 107" Height

Hanging / Shelving Tower

8" - 30" Depth
6" - 107" Height
4" - 48" Width
Overall Hanging Depth 22"
37" Min. Hanging Height Space

Shelving / Long Hanging Tower

8" - 30" Depth
6" - 107" Height
4" - 48" Width
Overall Hanging Depth 22"
60" Min. Hanging Height Space

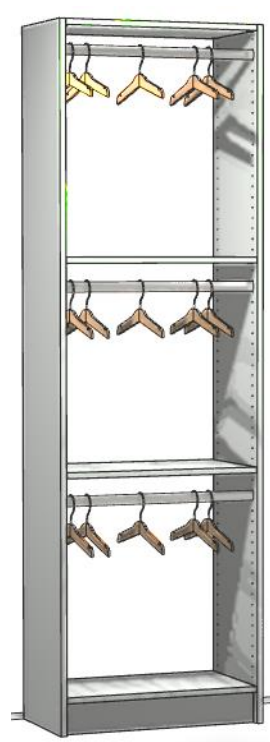
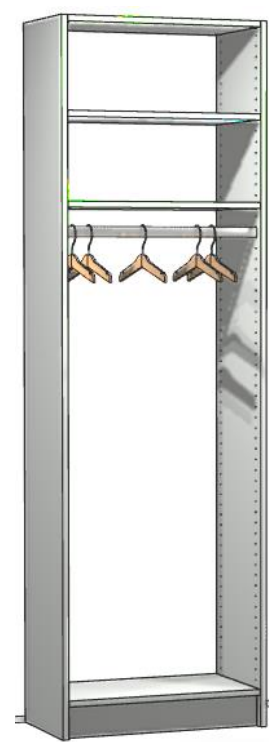
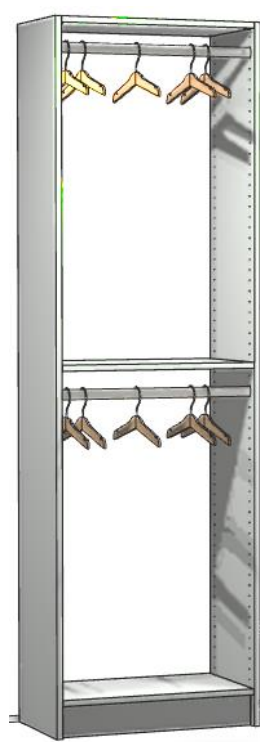
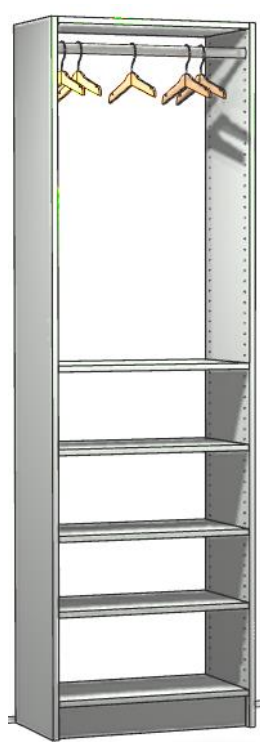
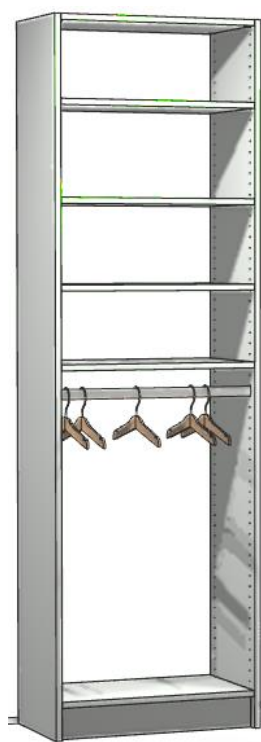
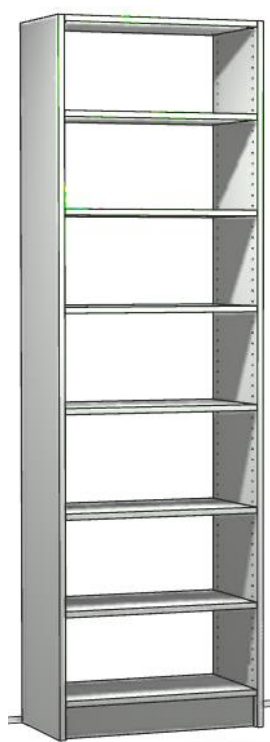

TOWERS - Drawers

Shelving / Drawers Tower

12" - 30" Depth
6" - 107" Height
8" - 36" Width
Drawer Heights 6"/8"/9"/12"
Drawer Depths 12"/14"/16"/18"/22"
Mix & Match Sizes

Hanging / Drawers / Shelving Tower

12" - 30" Depth
6" - 107" Height
Overall Hanging Depth 22"
Drawer 8" - 36" Width
Drawer Heights 6"/8"/9"/12"
Drawer Depths 12"/14"/16"/18"/22"
Mix & Match Sizes

Shelving / Drawers / Cubby Tower

Tower 12" - 30" Depth
Tower 6" - 107" Height
Drawer 8" - 36" Width
Drawer Heights 6"/8"/9"/12"
Drawer Depths 12"/14"/16"/18"/22"
Mix & Match Sizes

Hanging / Drawers Tower

12" - 30" Depth
6" - 107" Height
Overall Hanging Depth 22"
Drawer 8" - 36" Width
Drawer Heights 6"/8"/9"/12"
Drawer Depths 12"/14"/16"/18"/22"
Mix & Match Sizes

Shelving / Drawers / Shelving Tower

12" - 30" Depth
6" - 107" Height
Drawer 8" - 36" Width
Drawer Heights 6"/8"/9"/12"
Drawer Depths 12"/14"/16"/18"/22"
Mix & Match Sizes



TOWERS - DOORS

Shelving Tower / Long Doors

8" - 30" Depth
6" - 107" Height
4" - 48" Width

Single Door Max: 24" Wide
Door Max: 96" Height

Hanging / Shelving / Split Door

8" - 30" Depth
6" - 107" Height
4" - 48" Width

Hanging Requires 24" Depth Behind Doors
1 Rod Requires 37" Min. Height

Hanging / Long Door

8" - 30" Depth
6" - 107" Height
4" - 48" Width

Single Door Max: 24" Wide
Door Max: 96" Height
Hanging Requires 24" Depth Behind Doors
2 Rods Require 84" Min. Height

Shelving / Split Doors

8" - 30" Depth
6" - 107" Height
4" - 48" Wide

Hanging / Split Door

8" - 30" Depth
6" - 107" Height
4" - 48" Width

Hanging Requires 24" Depth Behind Doors
2 Rod Require 84" Min. Height

Drawers / Shelving / Single Door

12-30" Deep
6" - 107" Height
8" - 36" Width
Drawer Heights 6"/8"/9"/12"
Mix & Match Sizes

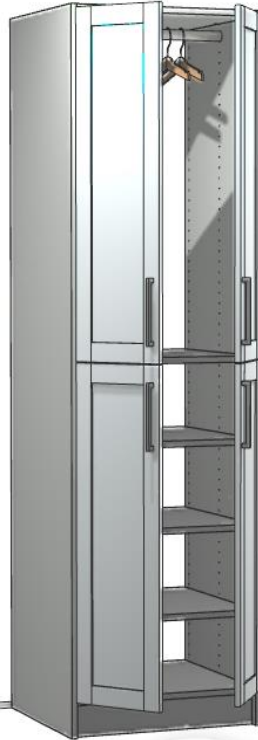

Towers - shoe shelves

Angled Shoe Tower

14" to 30" Depth
6" to 107" Height
8" to 37" Width

Shelves / Angled Shoe Shelves

14" to 30" Depth
6" to 107" Height
8" to 37" Width

Angled Shoes Shelves / Cubby

14" to 30" Depth
6" to 107" Height
8" to 37" Width

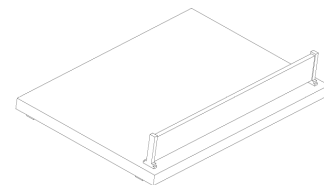

Shoe fences are sizeable.

Colors Available:
Chrome
Matte Aluminum
Matte Gold
Slate
Black

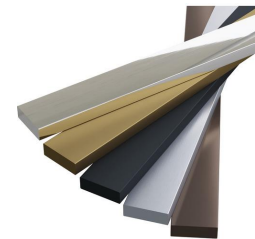

Towers-Trays

Shelves/Jewelry or Belt/ Drawers

24" or 26.5" (with spacers) Width Only
14" Depth Tray Only - Fits 14" - 30" Depth Space
6" / 8" or 12" (x 2 Trays) Drawer Front Heights
Mix & Match

Shoe fences/Jewelry or Belt/ Shelves

24" or 26.5" (with spacers) Width Only
14" Depth Tray Only - Fits 14" - 30" Depth Space
6" / 8" or 12" (x 2 Trays) Drawer Front Heights
Mix & Match

Shelves/Jewelry or Belt/ Shelves

24" or 26.5" (with spacers) Width Only
14" Depth Tray Only - Fits 14" - 30" Depth Space
6" / 8" or 12" (x 2 Trays) Drawer Front Heights
Mix & Match



- Flip Down Front with Slide-Out Tray.
- Available in Grey Felt Tray at 14" Depth Only.
- Jewelry Tray 2" Height
- Belt Tray 4" Height

Towers- Pullouts

Pull-out Pant Rack

18" / 24" / 30" Width Only

20.5" / 26.5" / 32.5" Width Only (spacers for behind doors)

14" Depth Only - Fits 14" - 30" Depth Space

Combine Drawers, Shelves, Wire Baskets, etc. with Pullout.

Pull-out Hamper Rack

18" / 24" / 30" Width Only

20.5" / 26.5" / 32.5" Width Only (spacers for behind doors)

14" Depth Only - Fits 14" - 30" Depth Space

Combine Drawers, Shelves, Wire Baskets, etc. with Pullout.

Pant Rack

Width: 18" = 12 Hangers

Width: 24" = 18 Hangers

Width: 30" = 24 Hangers

Depth: 14" only

Requires Min. 26" Height

Laundry Hamper

Width: 18" = 1 Bag

Width: 24" = 2 Bag

Width: 30" = 2 Bag

Depth: 14" Only

Requires Min. 21" Height

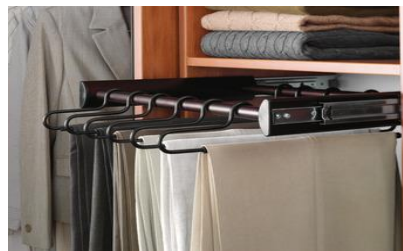
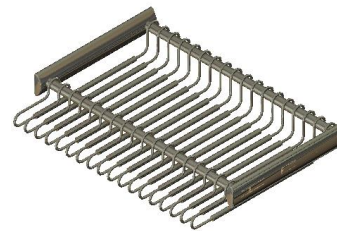

Colors Available:

Chrome

Matte Aluminum

Matte Black

Towers-Hamper

Tilt-Out Hamper Basket with Optional Cloth Liner

18" – 37" Width Range (18" / 24" / 30" Standard)

14" Depth only - Fits 14" -30" Depth Space

Optional Cloth Liner

All 5 colors available

Combine Drawers, Shelves, Wire Baskets, etc. with Tilt-Out.

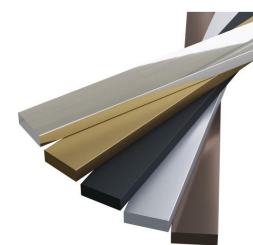

Colors Available:

Chrome

Matte Aluminum

Matte Gold

Slate

Black

Tilt-Out Hamper Fabric with Optional Cloth Liner

18" – 37" Width Range (18" / 24" / 30" Standard)

14" Depth only - Fits 14" -30" Depth Space

Black Only

Combine Drawers, Shelves, Wire Baskets, etc. with Tilt-Out.



Tilt-out Laundry Hamper - Basket

Width: 18" = 1 Basket

Width: 24" = 1 Basket

Width: 30" = 1 Basket

Depth: 14" Only

Requires Min. 27" Height

Tilt-out

All 5 colors available

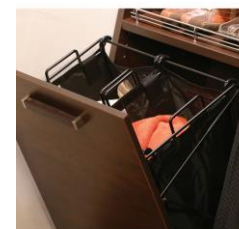

Tilt-out Laundry Hamper - Fabric

Width: 18" = 1 Bag

Width: 24" = 2 Bags

Width 30" = 2 Bags

Depth: 14" Only

Requires Min. 27" Height

Tilt-out

Black Only

Towers- Pullouts

Pull-out Mirror

48" Min. Height Required
14" Min. Depth Required
Combine Drawers, Shelves,
Wire Baskets, etc. with Mirror.

Chrome - N/A
Matte Aluminum
Matte Gold
Slate
Black

Valet Rod

Can fit between shelves
14" Min. Depth Required

Belt Rack

50" Min. Height Required
14" Min. Depth Required

Tie Rack

32" Min. Height Required
14" Min. Depth Required

Scarf Rack

35" Min. Height Required
14" Min. Depth Required

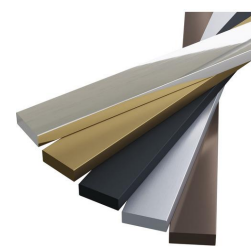

Colors Available:
Chrome
Matte Aluminum
Matte Gold
Slate
Black



Towers- Baskets

Pull-out Wire Basket

Baskets 18" / 24" / 30" Width Only
20.5" / 26.5" / 32.5" Width Only (spacers for behind doors)
14" Depth Only - Fits 14" - 30" Depth Space
3 Basket Heights: 6" / 11" / 17"
Combine Drawers, Shelves, etc. with Baskets.

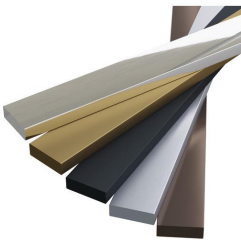

Colors Available:
Chrome
Matte Aluminum
Matte Gold
Slate
Black

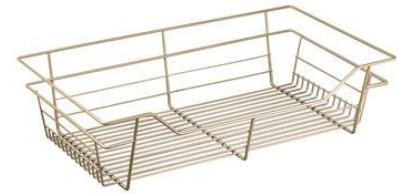

Ironing Drawer

Ironing Board
Fits 21" - 35" Width Only
14" Depth Only - Fits 14" - 30" Depth Space
Requires Fixed Shelf Below For Mounting
Slides-Out, Unfolds and Rotates
Combine Drawers, Shelves, etc. with Ironing Board.

Width: 20.5" Wide
Height: 5.5"
Depth: 14" Only
Slide-Out / Flip Front
White with Fabric Cover



Towers-



Towers- Rod Pull Down

Pull-down Closet Rod

Fits 27.25" - 47.5" Width Space

Fits 14" - 30" Depth Space

Soft-close in Retracting Mode Only

Combine Drawers, Shelves, etc. with Pull-Down Rod.

Black/Chrome

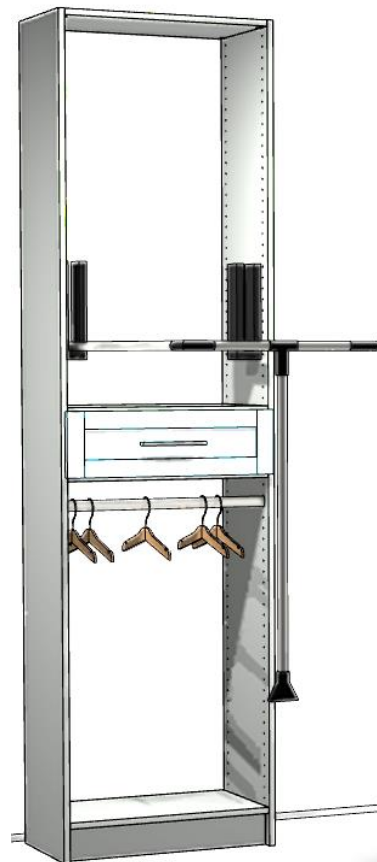
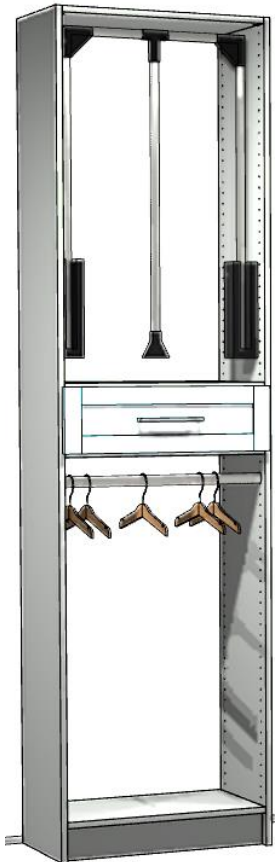
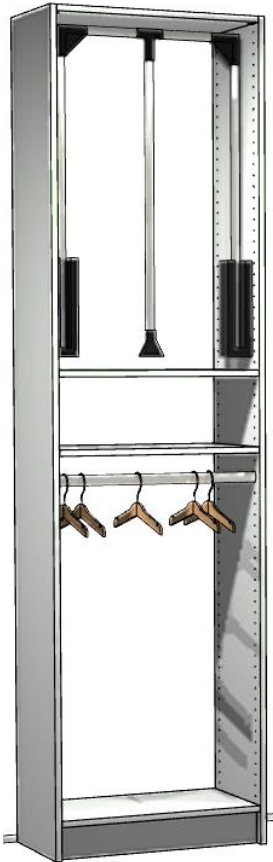

Towers- Corners

Corner Module - Angled Shelves

8" - 30" Depth
6" - 107" Height
24" - 48" Width
Mix & Match Shelves
Must use Angled Shelves for Doors

Corner Module - Hanging

8" - 30" Depth
6" - 107" Height
24" - 48" Width
Mix & Match Shelves
Doors NOT available with Radius Shelves

Corner Module - Radius Shelves

8" - 30" Depth
6" - 107" Height
24" - 48" Width
Mix & Match Shelves
Doors NOT available with Radius Shelves

Corner Module - Doors

8" - 30" Depth
6" - 107" Height
24" - 48" Width
Mix & Match Shelves
Must use Angled Shelves for Doors
Door Max: 96" Height

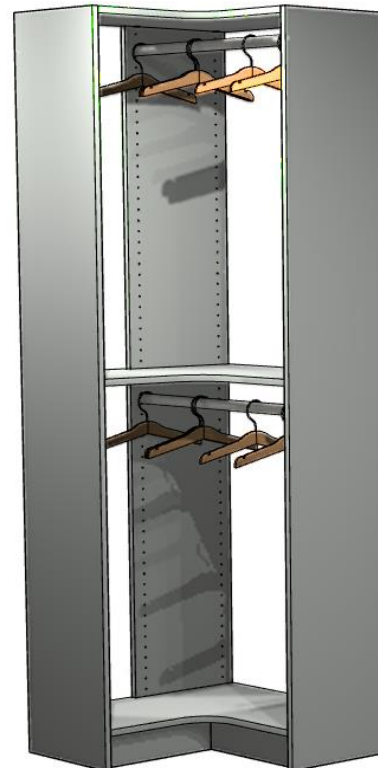
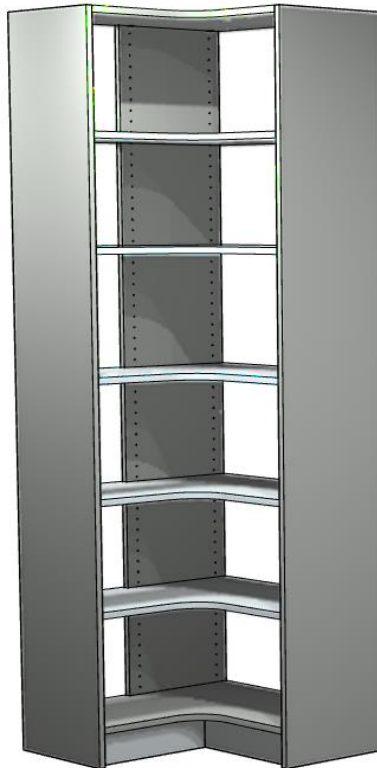
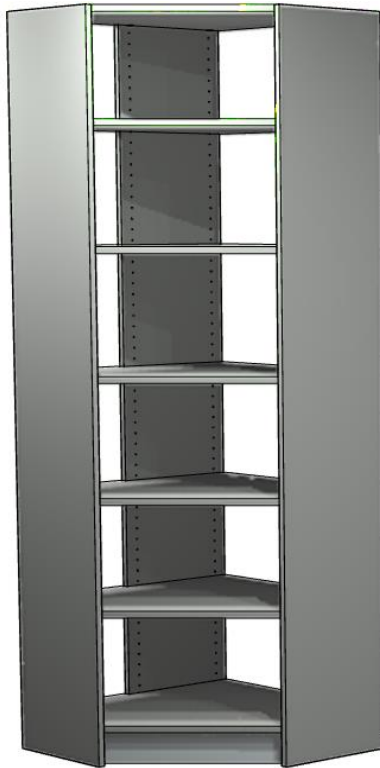

Outside Corners

Outside Corner Shelves - Angled Shelves (Left or Right)

8" - 24" Depth

6" - 107" Height

8" - 24" Width

Door Max: 96" Height

Fixed Shelves ONLY – Must Unscrew Hardware for Adjustability

Combine Drawers, Shelves, Doors, etc. on connecting Tower.

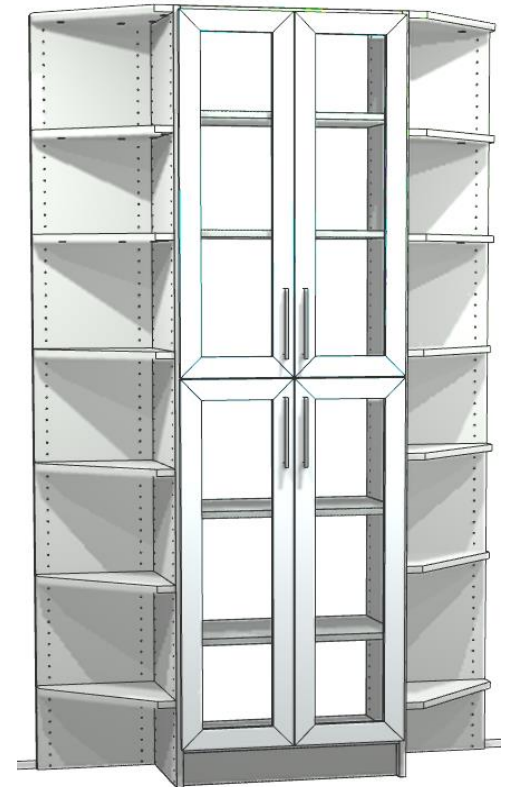
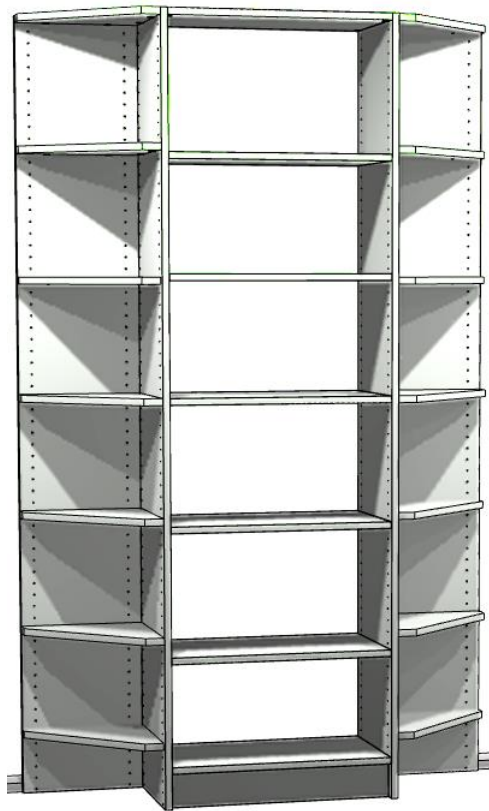

Towers-



Towers-Base Towers

Shelving Tower
4" - 48" Width
8" - 30" Depth

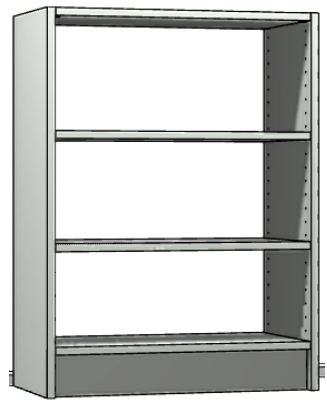

Shelving Tower / Single Door
4" - 48" Width
8" - 30" Depth
Single Door Max: 24" Wide

Drawers / Shelving Tower
8" - 36" Width
12" - 30" Depth
Choose 6" / 8" / 9" / 12" Heights
Mix & Match Sizes



Shelving Tower / Single Door
With TOP
4" - 48" Width
8" - 30" Depth
Single Door Max: 24" Wide



Towers-Island Tower

Islands

4" - 48" Width

12" / 14" / 16" / 19" / 24" Depth Per side

24" x 24" Depth is Not available

Multiple Modules may be Connected Together (2 Plus)

Shelves, Doors, Drawers, Accessories are all available in the modules

Note: Single door max 24"



Wall-Hanging Shelves

Double Hanging Tower

8" - 15" Depth
12" - 84" Height
8" - 48" Width

Overall Hanging Depth 22"
2 Rods Require 48" Min. Height Tower
2 Rods Require 84" Min. Height From Floor

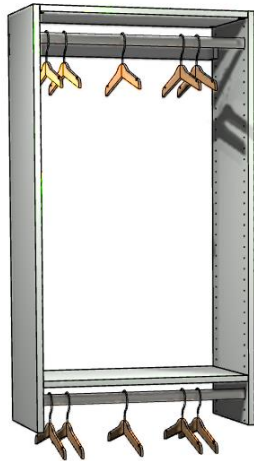

Long Hanging Tower (Dresses)

8" - 15" Depth
12" - 84" Height
8" - 48" Width

Overall Hanging Depth 22"
1 Rod Requires 60" Min. Height

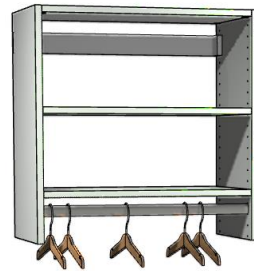

Triple Hanging Tower (KIDS)

8" - 15" Depth
12" - 84" Height
8" - 48" Width

Overall Hanging Depth 22"
3 Rods Require 26" Min. Height Each
3 Rods Require 65" Min. Height Tower
3 Rods Require 84" Min. Height From Floor

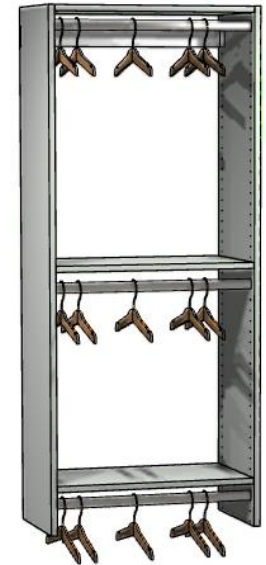

Single Hang / Shelving Tower

8" - 15" Depth
12" - 84" Height
8" - 48" Width

Overall Hanging Depth 22"
1 Rod Requires 37" Min. Hanging Space

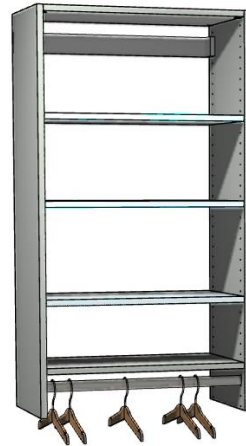

Double Hanging / Drawers Tower

8" - 15" Depth
12" - 84" Height
8" - 36" Width

Overall Hanging Depth 22"
56" Min. Height Tower for 2 Rods with Drawer
91" Min. Height From Floor

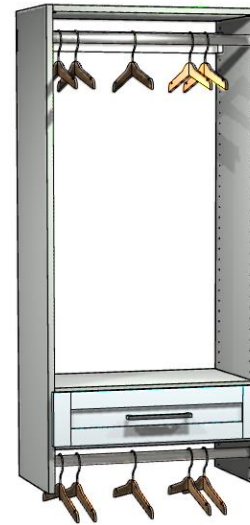

Wall-Tower Upper

Wall Shelving Tower

8" - 15" Depth
12" - 84" Height
8" - 48" Width

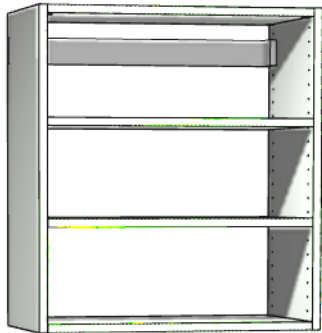

Wall Cabinet with Shelves/Doors

8" - 15" Depth
12" - 84" Height
4" - 48" Width

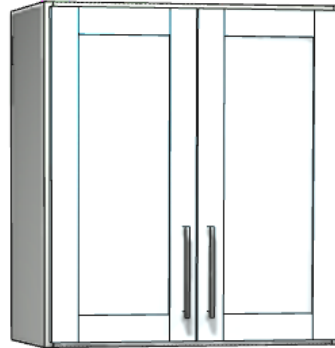

Wall Cabinet with LIFT Door

8" - 15" Depth
9" - 15" Height
22" - 48" Width



Closest

Colors Available:
Chrome
Matte Aluminum
Matte Gold
Slate
Black

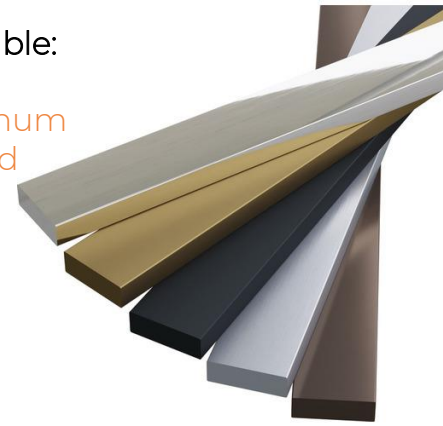

Round Closet Rod
1-5/16" Diameter



Belt Rack
14" Depth
Slide - out

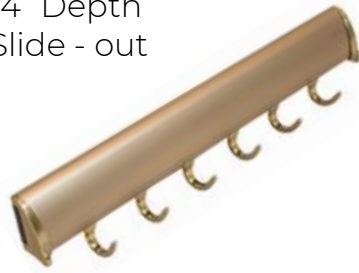

Scarf Rack
14" Depth
Slide - out



Valet Rod
14" Depth
Slide - out



Shoe Fence
Width: 12" / 18" / 24"
/ 30" / 36"
Trimmable



Wire Basket
14" Depth
18" / 24" / 30" Width
6" / 11" / 17" Height
Slide - out

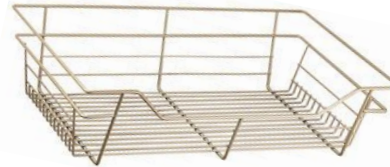

Tilt-out Laundry Hamper
Basket w/ optional Liner
14" Depth
18" / 24" / 30" Width



Tie Rack
14" Depth
Slide - out



Single Coat Hook
6-1/4" Height
3-5/8" Depth



Double Coat Hook
3-1/2" Width
2-1/2" Depth



Mirror
48" Height
14" Depth
Not Available:
Chrome



Closest

Slide-out Pant Rack

W: 18" = 12 hangers
W: 24" = 18 hangers
W: 30" = 24 hangers
D: 14" Only
Requires 26" H
Slide-out
Chrome
Black
Aluminum



Slide-out Laundry Hamper

W: 18" = 1 Bag
W: 24" = 2 Bag
W: 30" = 2 Bag
D: 14" Only
Requires 21" H
Slide-out
Chrome
Black
Aluminum



Tilt-out Laundry Hamper

W: 18" = 1 Bag
W: 24" = 2 Bag
D: 14" Only
Requires 27" H
Tilt-out
Black



Pull-down Rod

W: 27.25" to 47.5"
D: 14" to 30" space
Requires 40" H
Soft-close up
Black/Chrome



Belt/Watch Tray

W: 24" Width only
Slide-out / Flip Front
H: 4"
D: 14" Only
Grey Only



Jewelry Tray

W: 24" Width only
Slide-out / Flip Front
H: 2"
D: 14" Only
Grey Only



Closest Rod Oval

1-3/16 Diameter
Chrome



Slide-out Ironing Board

W: 20.5" Width
H: 5.5"
D: 14" Only
Slide-out / Flip Front



Office



Omni Track



Aluminum Track Ends



Plastic Track Ends



Storage Bins (S/M/L)



Paper Tray



Keyboard Tray Combo



Filing System



Computer Arm with Desk Mount



File Hanger



Pencil Tray



Pop-up Power Station



Door Locks



Wall Mount



Small Tray



Power Data Station



Grommet 2 3/8"

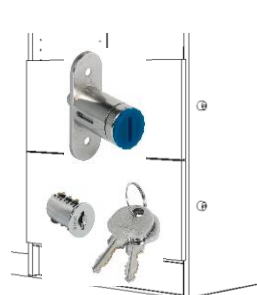

Drawer Locks



Track Mount



2 Computer Arms with Desk Mount

Handles



Handle 1

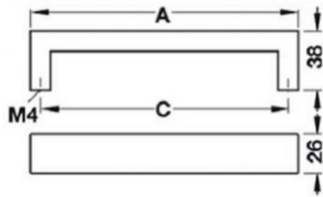

Stainless Steel
128 / 160 / 192
224 / 288 / 320
440mm



Round Knob

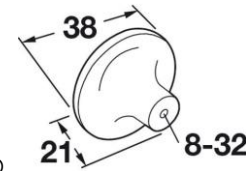

Chrome
Matte Black
Slate
Matte Gold
Matte Aluminum
38mm



Handle 2

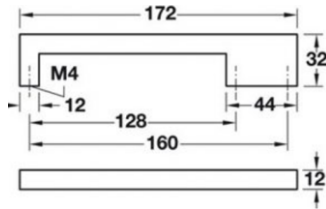

Chrome
Matte Black
Brushed Nickle
160mm



Square Knob

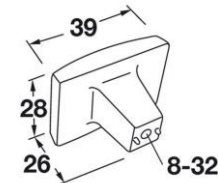

Chrome
Matte Black
Slate
Matte Gold
Matte Aluminum
39mm



Handle 3

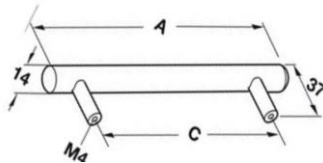

Stainless Steel
128 / 192 / 224
320 / 480mm

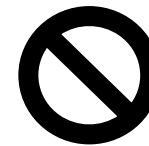

No Handles
Drawers



Push to Open
Slides for
Drawers



Handle 4

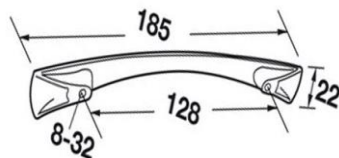

Chrome
Matte Black
Slate
Matte Gold
Matte Aluminum
128mm

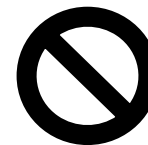

No Handles
Doors



Push to Open
Hinges for
Doors

Lighting

- Electrical components such as Drivers, Cables and Connectors will depend on the configuration of the lighting throughout the design.

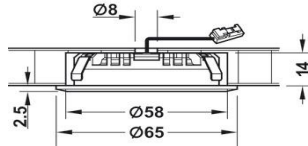

2.5" LED Light WW



LED Strip Lighting WW
5M adhesive roll

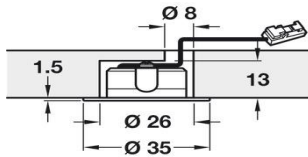

1 3/8" LED Light WW

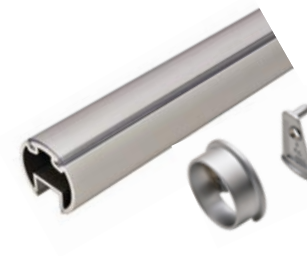

LED Strip Lighting
Closet Rod WW

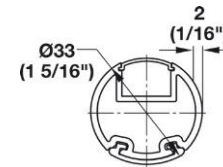

- Colors Available:
- Chrome
 - Matte Gold
 - Matte Aluminum
 - Matte Black
 - Slate



Door Activation Switch
Open door to activate light

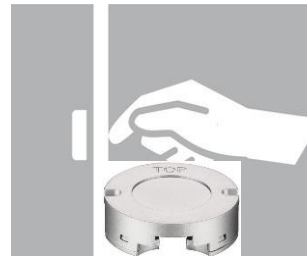

Concealed Touch switch
Mounted behind 3/4" wood valance or panel and touch to activate light

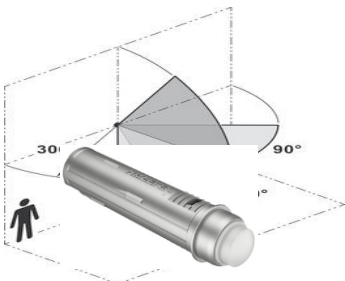

Motion Activation Switch
Motion sensor to activate light



Wall Switch
Lighting system to be used in conjunction with a dedicated wall plug operated by a on/off switch.

Lighting

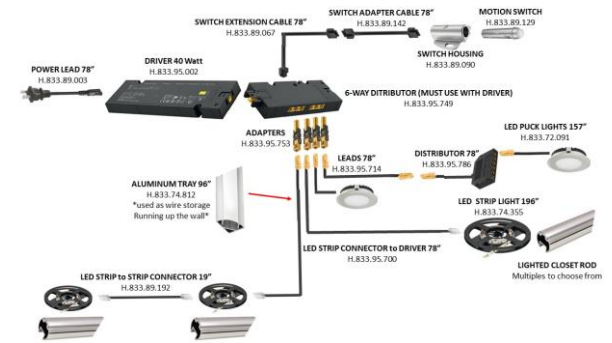

To Start: Layout the lights needed on the closet diagram and map the components below. Work from the lights to the wall socket detailing the leads and adapters needed. Once mapped and dimensions of the runs are less than the lead lengths then place the order within the 2020 Designs PFC catalog. *Don't be afraid to add extra leads just incase*

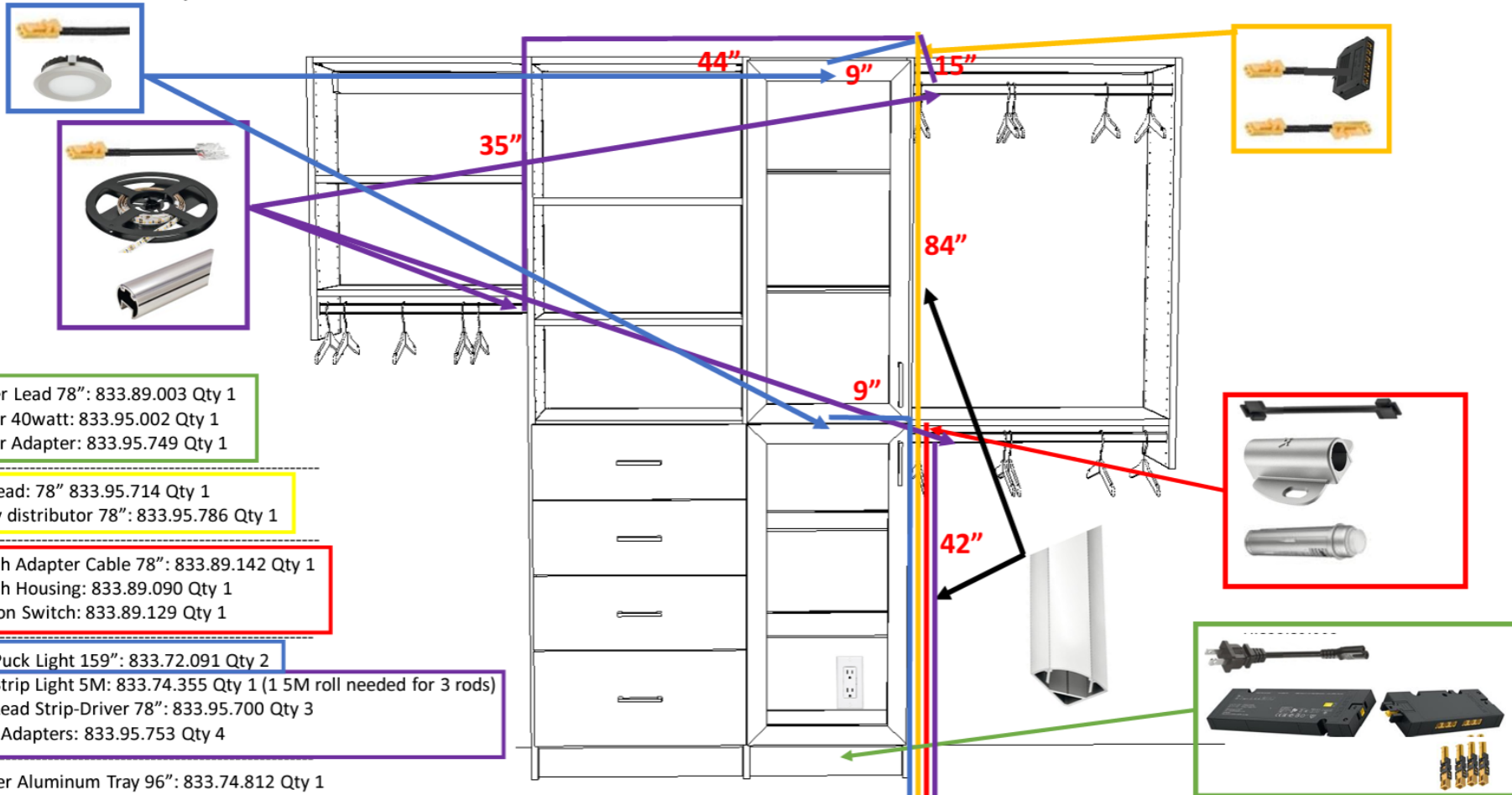

Power Lead 78": 833.89.003 Qty 1
 Driver 40watt: 833.95.002 Qty 1
 Driver Adapter: 833.95.749 Qty 1

Ext Lead: 78" 833.95.714 Qty 1
 6Way distributor 78": 833.95.786 Qty 1

Switch Adapter Cable 78": 833.89.142 Qty 1
 Switch Housing: 833.89.090 Qty 1
 Motion Switch: 833.89.129 Qty 1

LED Puck Light 159": 833.72.091 Qty 2
 LED Strip Light 5M: 833.74.355 Qty 1 (1 5M roll needed for 3 rods)
 LED Lead Strip-Driver 78": 833.95.700 Qty 3
 Light Adapters: 833.95.753 Qty 4

Corner Aluminum Tray 96": 833.74.812 Qty 1

Garage Cabinets



Garage Accessories

The Benefits

- ❑ Top & Bottom are 1" thick
- ❑ Panels are 3/4" thick
- ❑ Shelves are 1" thick
- ❑ Back Panel is 3/4" thick
- ❑ All exposed edges have zero joint 1mm edge banding (Top / Front / Bottom)
- ❑ Extra Line boring on the back is added for extra shelf support for widths greater than 31.5"
- ❑ Cabinets that are 24" deep have a 3rd shelf support on each side
- ❑ Adjustable garage legs can be added to each design. 5th center leg is used for larger cabinets

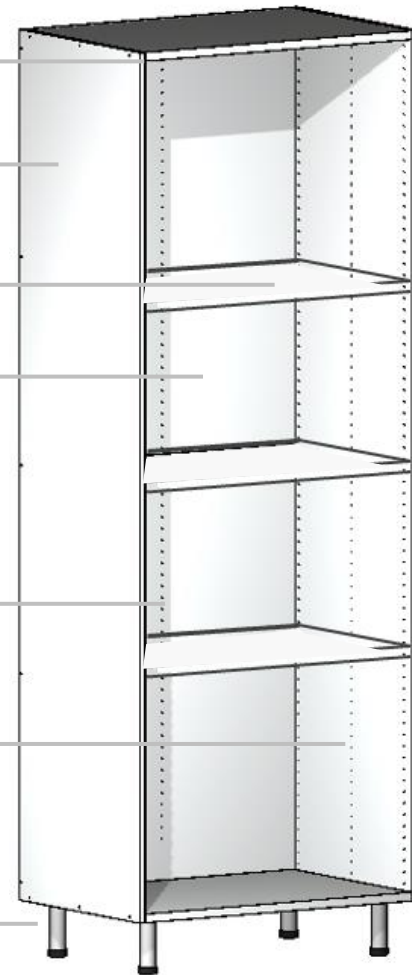





LEGEND - Exterior

TFL Level One

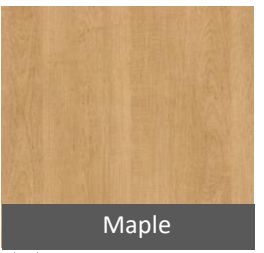
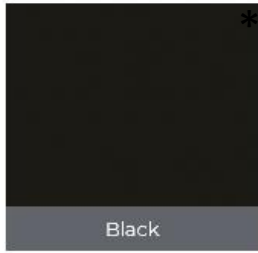

TFL Level Two



-  Garage Cabinet
 -  TFL Drawer Box
 -  HPL TOP - Garage
- Cabinet Exterior Additions

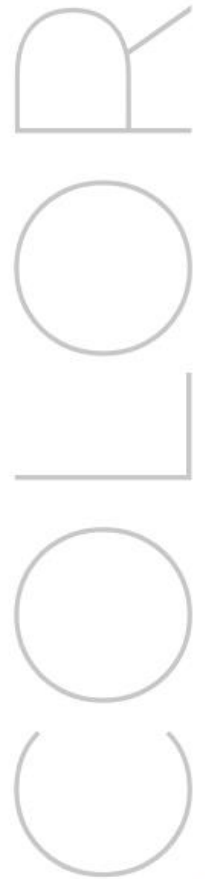

TFL Level Three



Apres Ski



Cassis



Esterel



Silverwood



Winter Fun



Super Matte Sunset Grey



Super Matte White



Super Matte Canadian Grey

TFL Level Four



Chiffon

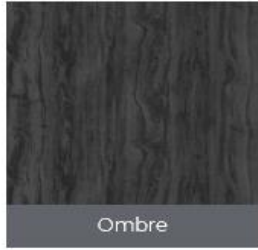

Ombre



Pietra



Rumour



Whisper



Super Matte Black



Super Matte Charcoal



Super Matte Sage

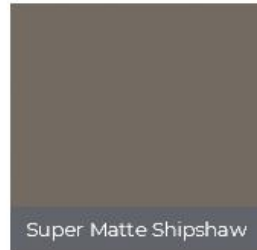

Super Matte Shipshaw

LEGEND - Exterior

 Garage Cabinet

 TFL Drawer Box

 HPL TOP - Garage

Cabinet Exterior Additions

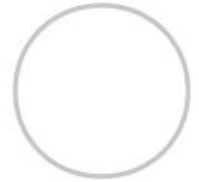

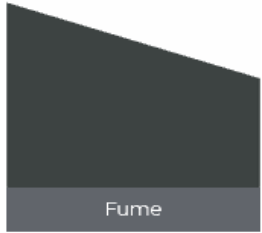
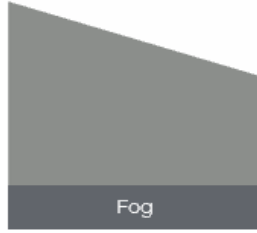
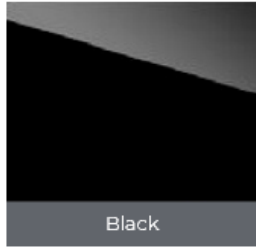
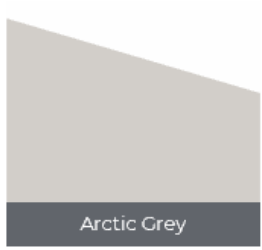

High Gloss

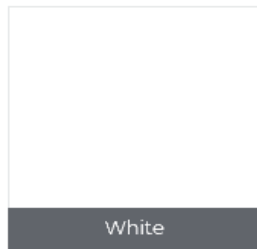
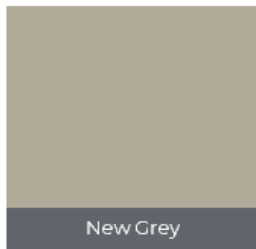
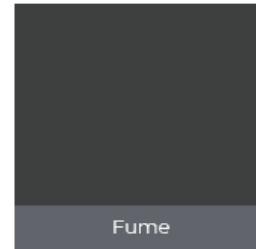
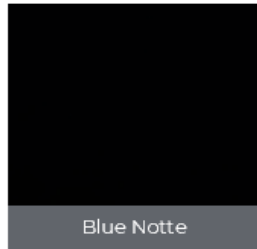
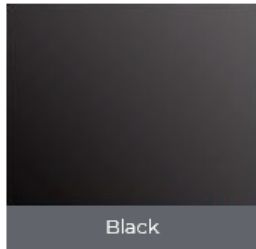

Matte



LEGEND - Exterior

-  Garage Cabinet
 -  TFL Drawer Box
 -  HPL TOP - Garage
- Cabinet Exterior Additions



HPL Tops (Garage)

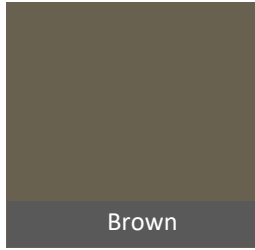
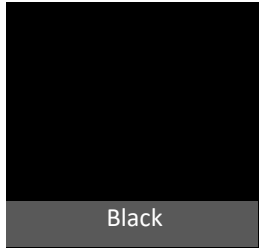

LEGEND - Exterior

 Garage Cabinet

 TFL Drawer Box

 HPL TOP - Garage



The System

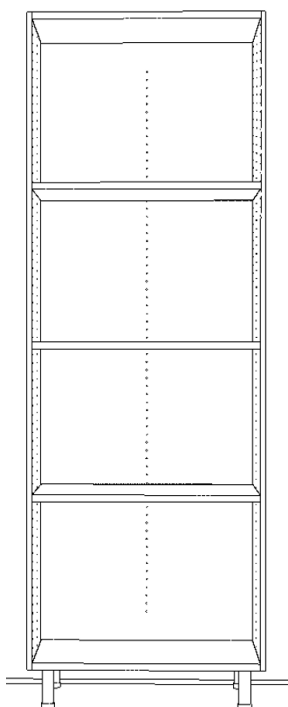

Garage Cabinets are available in 3 matching colors for all internal parts. External parts are available in multitude of different color options.

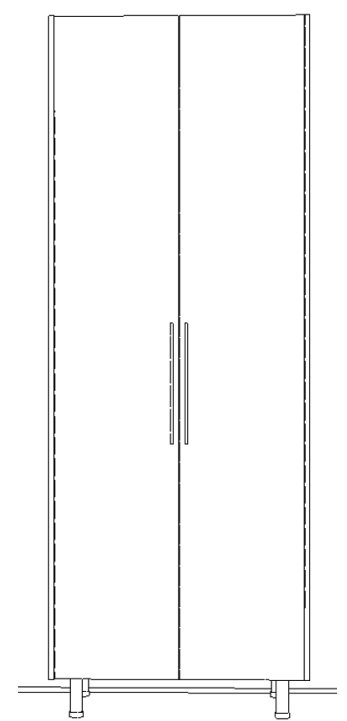

CABINET & DRAWER BOXES (TFL)
Colors Available:

WHITE / CANADIAN GREY / MAPLE

*Color options are due to 1" material availability

Colors available includes the following:
PANELS (3/4") / DECKS (Top/Bottom) (1")
SHELVES (1") / BACK (3/4") / TFL DRAWER BOX (3/4")

CABINET EXTERIOR ADDITIONS
Colors Available:

ALL TFL / MATTE / HIGH GLOSS COLORS
Including Cabinet colors

Colors available includes the following:
DOORS (3/4") / DRAWER FRONTS (3/4")
END PANELS (3/4")

Cabinets-Tall

Tall Cabinet

12" - 24" Depth
12" - 96" Height
12" - 48" Width

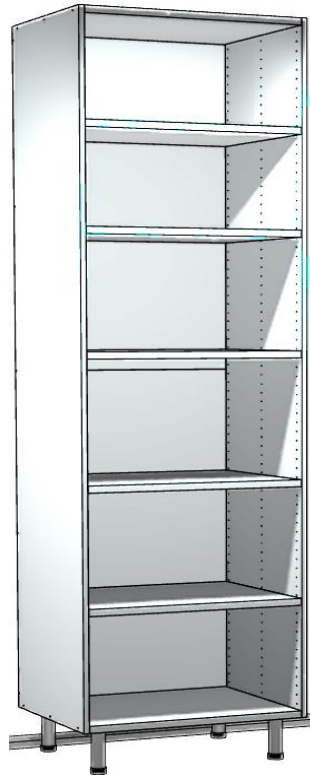

Tall Cabinet / Doors

12" - 24" Depth
12" - 96" Height
12" - 48" Width
Single Door Max: 24" Wide



Base Cabinet / Open

12" - 24" Depth
12" - 96" Height
12" - 48" Width

Base Cabinet / Doors

12" - 24" Depth
12" - 96" Height
12" - 48" Width

Note: Single door max 24" width

Base Cabinet / Drawers

14" - 24" Depth
12" - 96" Height
12" - 36" Width
Choose 6" / 8" / 9" / 12" Heights
Mix & Match Sizes

Cabinet TOPS

12" - 96" Width
12" - 48" Depth
1.125" Thickness

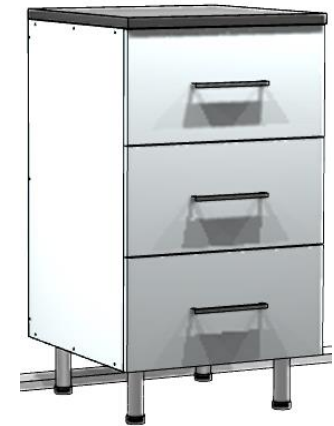
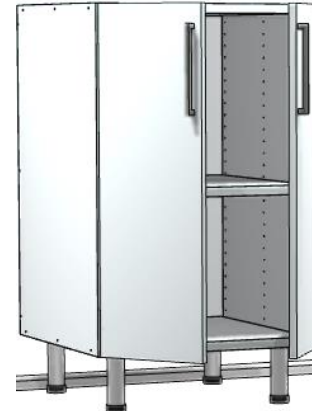
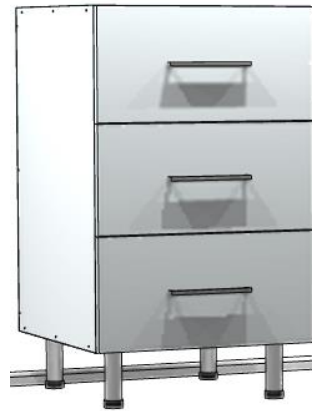
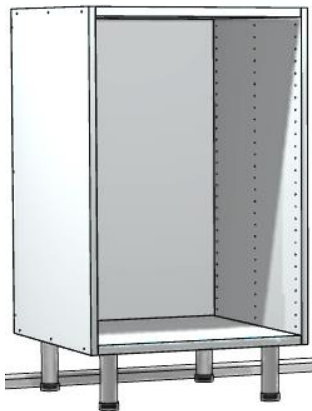

Upper Cabinet
12" - 14" Depth
12" - 31" Height
12" - 48" Width

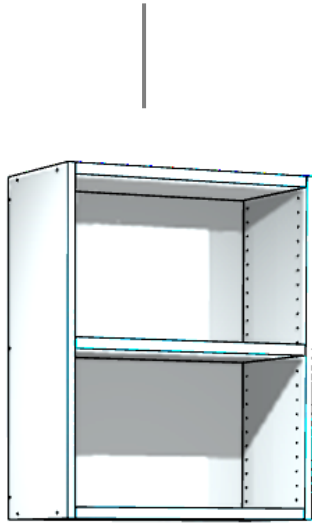

Upper Cabinet / Doors
12" - 14" Depth
12" - 31" Height
12" - 48" Width
Single Door Max: 24" Wide

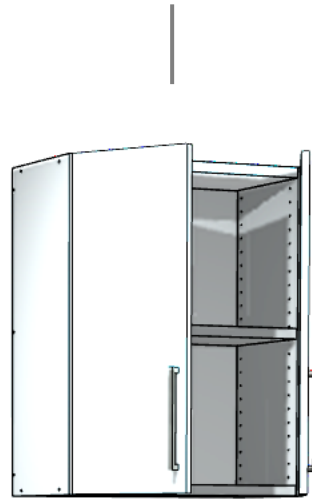

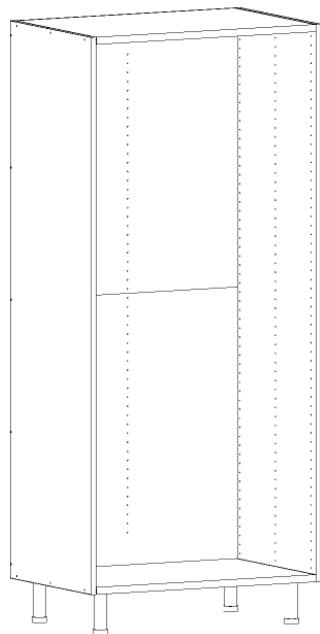

□ Tall Cabinet

Custom Width Range: 12" to 48"
Standard Widths: 18" / 24" / 30" / 36"

Custom Depth Range: 12" to 24"
Standard Depths: 24"

Custom Height Range: 12" to 96"
Standard Heights: 90" - 96"

Thickness: 3/4" & 1" mix

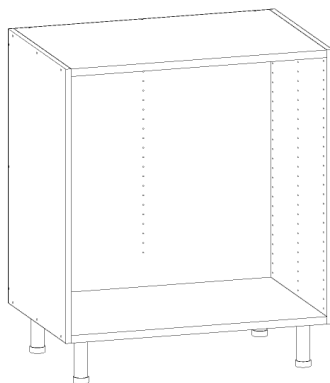

□ Base Cabinet

Custom Width Range: 12" to 48"
Standard Widths: 18" / 24" / 30" / 36"

Custom Depth Range: 12" to 24"
Standard Depths: 24"

Custom Height Range: 12" to 96"
Standard Heights: 90" - 96"

Thickness: 3/4" & 1" mix

- Default edge-banding locations apply to individual parts.
- Parts can be custom sized at no extra charge.



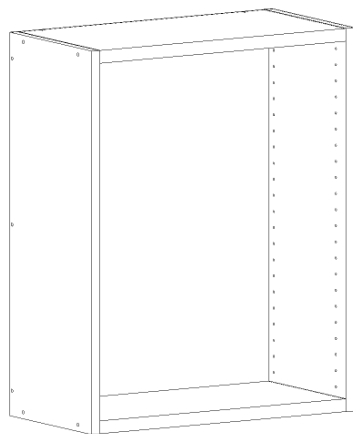

Upper Cabinet

Custom Width Range: 12" to 48"
Standard Widths: 18" / 24" / 30" / 36"

Custom Depth Range: 12" to 14"
Standard Depths: 12"

Custom Height Range: 12" to 31"
Standard Heights: 30"

Thickness: 3/4" & 1" mix



End Panel

Custom Depth Range: 12 7/8" to 24 7/8"
Standard Depths: Cabinet Dept + 7/8"

Custom Height Range: 12" to 96"
Standard Heights: Cabinet Height

Thickness: 3/4"

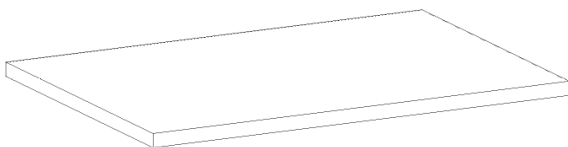

Cabinet HPL TOP

Custom Width Range: 6" to 96"

Custom Depth Range: 12" to 48"
Standard Depths: 25"

Thickness: 1 1/8"

- Default edge-banding locations apply to individual parts.
- Parts can be custom sized at no extra charge.



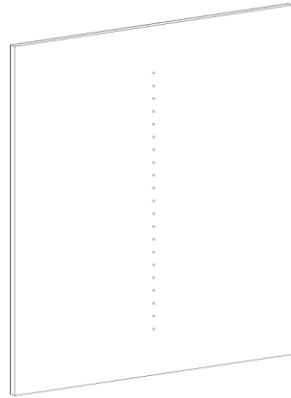

Back Panel

Custom Width Range: 10 1/2" to 46 1/2"
Standard Widths: 16 1/2" / 22 1/2" / 28 1/2" / 34 1/2"

Custom Height Range: 10" to 95"
Standard Heights: Cabinet Height

Thickness: 3/4"



Shelves – Fixed (cam)

Custom Width Range: 10" to 46"
Standard Widths: 16 1/2" / 22 1/2" / 28 1/2" / 34 1/2"

Custom Depth Range: 11 1/4" to 23 1/4"
Standard Depths: 11 1/4" / 13 1/4" / 15 1/4" / 18 1/4" / 23 1/4"

Thickness: 1"

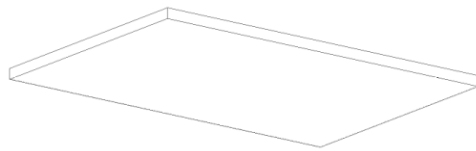

Shelves – Adjustable

Custom Width Range: 10" to 46"
Standard Widths: 16 1/2" / 22 1/2" / 28 1/2" / 34 1/2"

Custom Depth Range: 11 1/4" to 23 1/4"
Standard Depths: 11 1/4" / 13 1/4" / 15 1/4" / 18 1/4" / 23 1/4"

Thickness: 1"

- Default edge-banding locations apply to individual parts.
- Parts can be custom sized at no extra charge.





❑ Filler

Custom Width Range: 3" to 10"

Standard Width: 3"

Custom Height: Range: 6" to 108"

Thickness: 3/4"



❑ Door Profile – Euro

Custom Width Range: 12" to 48"

Standard Widths: 17 7/8" / 23 7/8" / 29 7/8" / 35 7/8"

Custom Height: Range: 12" to 96"

Thickness: 3/4"



❑ Drawer Profile – Euro

Custom Width Range: 12" to 36"

Standard Widths: 17 7/8" / 23 7/8" / 29 7/8" / 35 7/8"

Custom Height Range: 6" / 8" / 9" / 12"

Thickness: 3/4"

- Default edge-banding locations apply to individual parts.
- Parts can be custom sized at no extra charge.





■ Euro



- 3/4" thick TFL board
- Available in all colors
- Matching 1mm edge-banding
- Max size of 24"W x 96"H per door
- Zero Joint, superior smooth corner edge-banding



- 110' Soft-Close Hinges defaulted on all Doors

Profiles



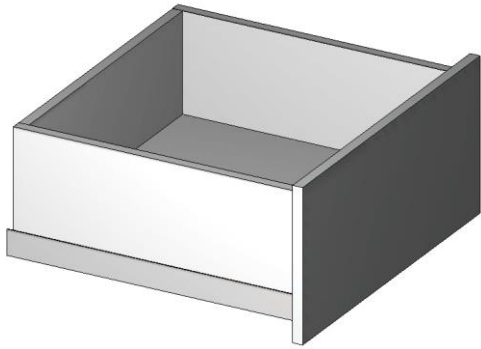

3 TFL Colors

- ❑ TFL drawer boxes are available in matching White, Maple & Canadian Grey finishes.
- ❑ Soft-close or Push-to-Open slides are used with every drawer box.
- ❑ DTC's concealed undermount Slides featuring Soft-Close, full extension and a 4-way adjustment locking clips.



TFL Drawer Box

3/4" Thick Walls & 3/4" Thick Bottom
Undermount Soft-close Slides
Push to Open Slides available
1 1/4" Spacers available for install behind doors



Custom Width Range: 8" to 36"
Standard Widths: 18" / 24" / 30"
Standard Heights: 6" / 8" / 9" / 12"
Standard Depths: 12" / 14" / 16" / 18" / 22"

Dovetail Drawer Box

5/8" Thick Walls & 1/4" Thick Bottom
Undermount Soft-close Slides
Push to Open Slides available
1 1/4" Spacers available for install behind doors



Custom Width Range: 8" to 36"
Standard Widths: 18" / 24" / 30"
Standard Heights: 6" / 8" / 9" / 12"
Standard Depths: 12" / 14" / 16" / 18" / 22"

Scooped Dovetail Drawer Box

5/8" Thick Walls & 1/4" Thick Bottom
Undermount Soft-close Slides
Push to Open Slides available
1 1/4" Spacers available for install behind doors



Custom Width Range: 8" to 36"
Standard Widths: 18" / 24" / 30"
Standard Heights: 2" / 3" / 6" / 8"
Standard Depths: 12-5/8" / 14-5/8" / 16-5/8"
Depths Continued: 18-5/8" / 22-5/8"



Garage

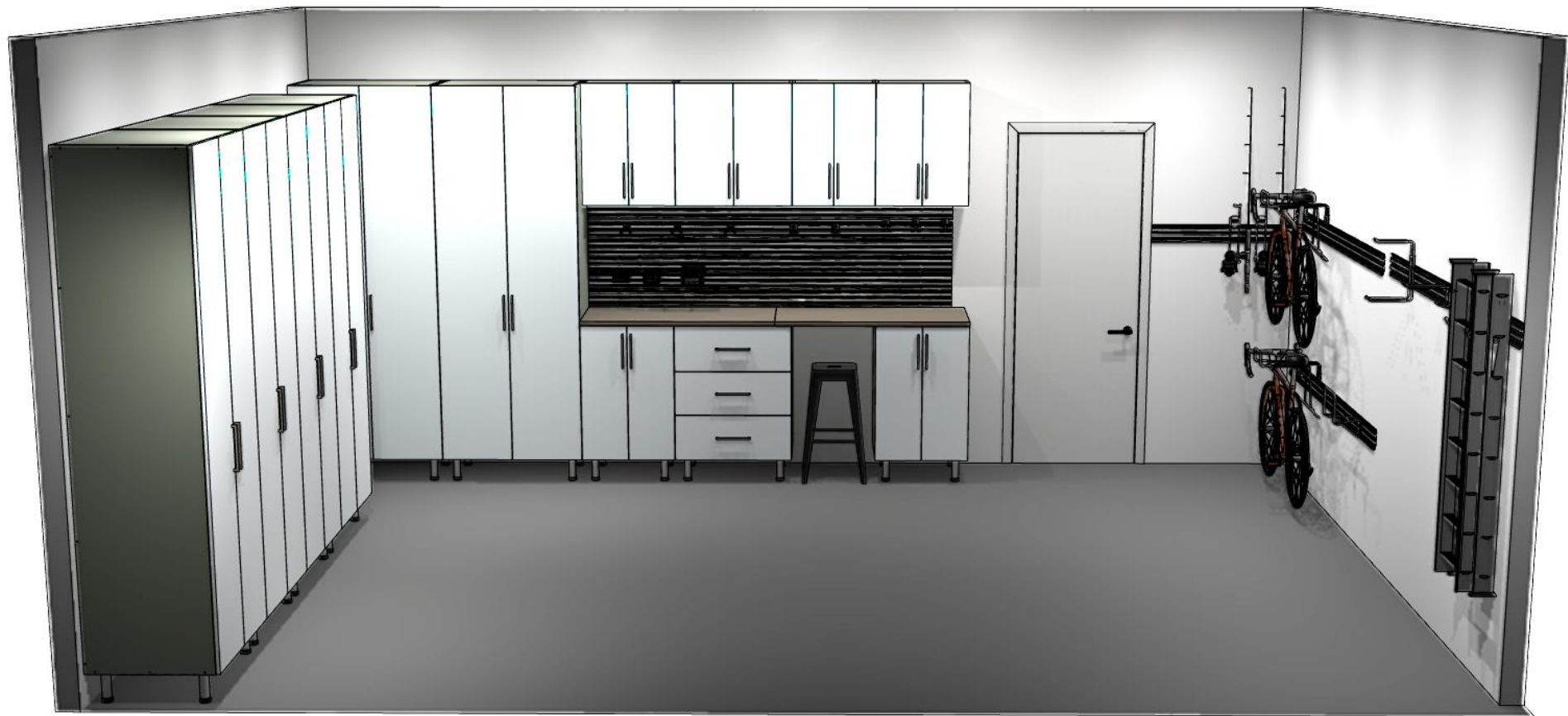

Garage

Wall B

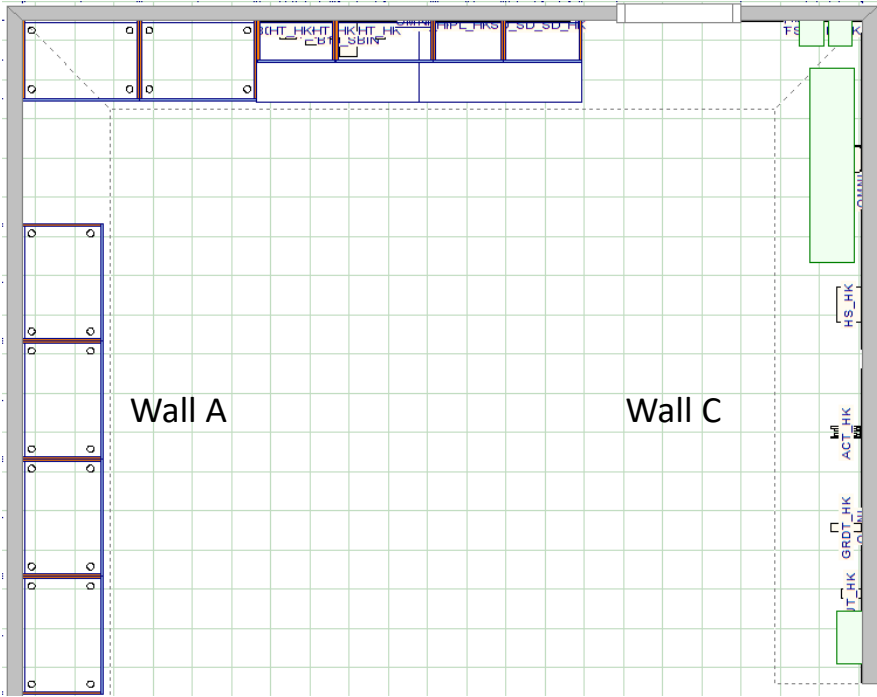

Wall A

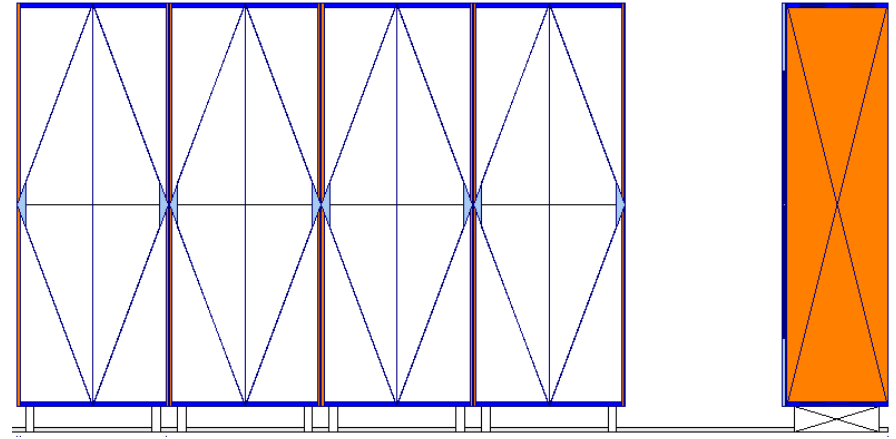

Wall B

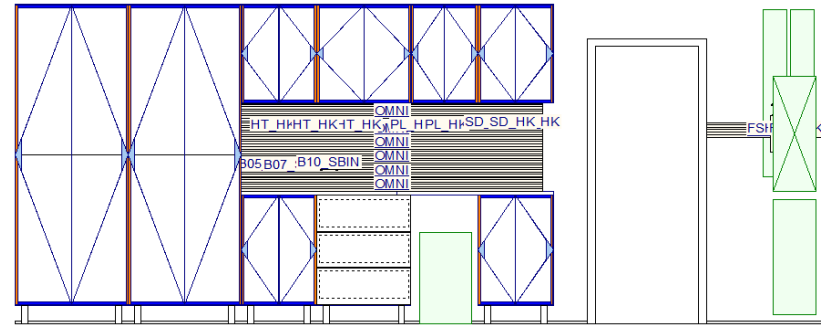

Wall C

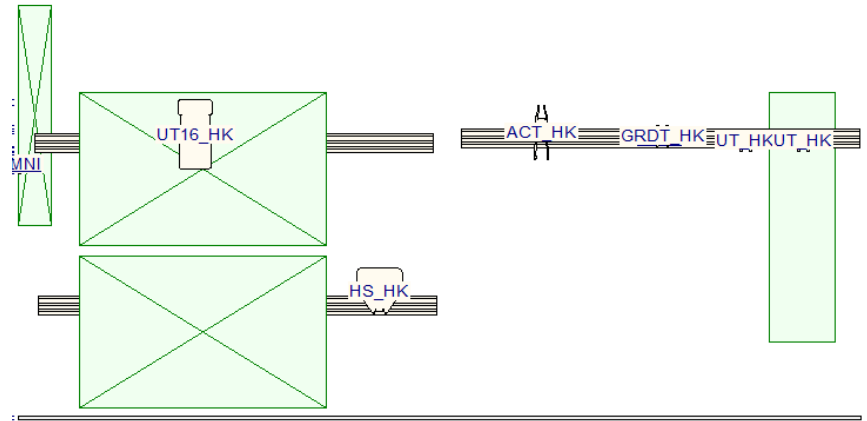

Garage

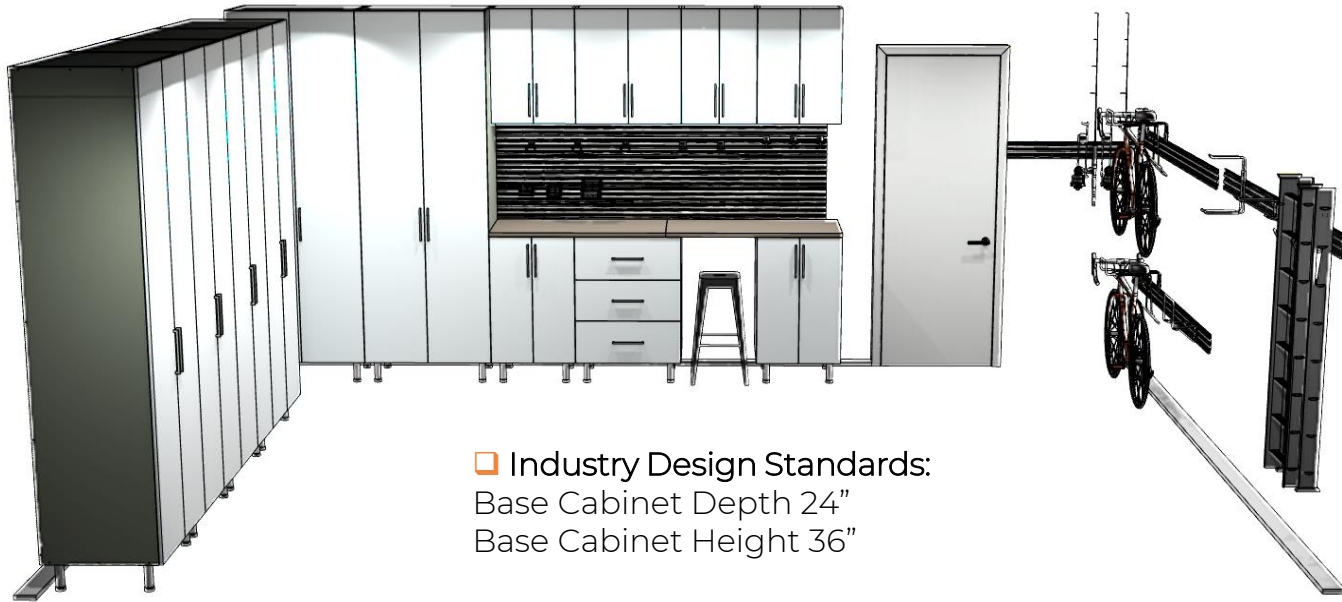

Industry Design Standards:
Base Cabinet Depth 24"
Base Cabinet Height 36"

Upper Cabinet Depth 12" or 14"
Upper Cabinet Height 24" to 31"

Tall Cabinets Depth 19" or 24"
Tall Cabinets Height 90" to 96"

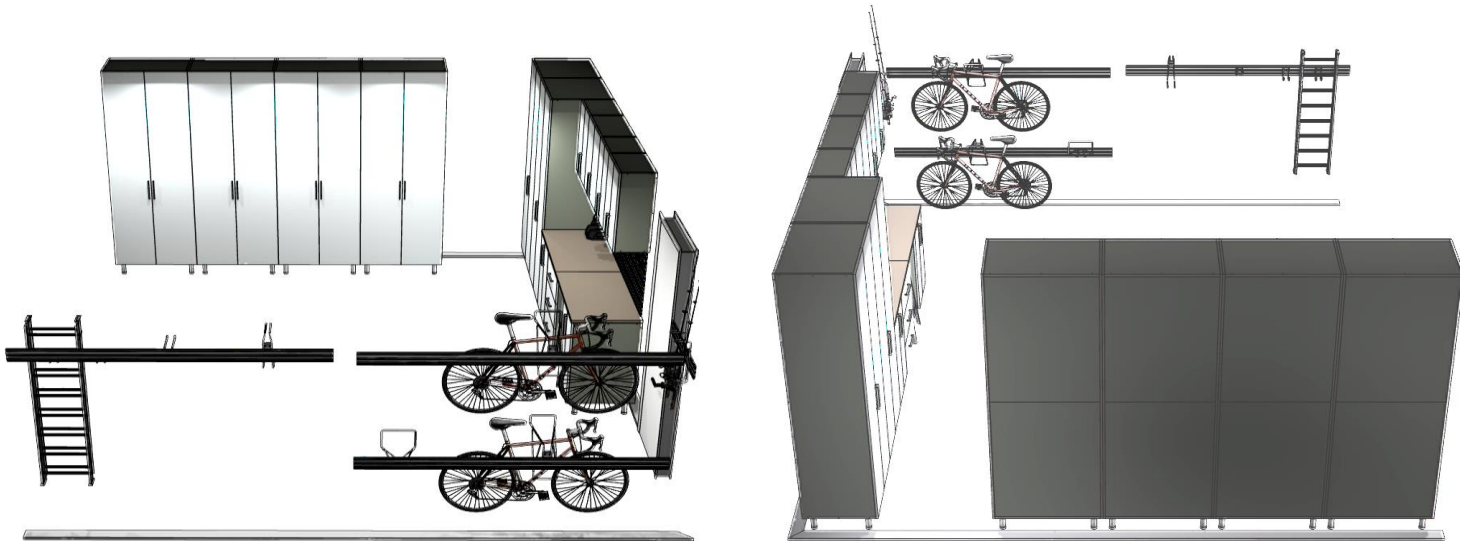

Garage



Omni Track



Aluminum Track Ends



Plastic Track Ends



Screwdriver Hook



Activity Hook



Hand Tool Hook



Garden Hook



Utility Hook



Pliers Hook



Wrench Hook



Horizontal Bike Hook



Hose Hook



Vertical Bike Hook



Paper Towel Organizer



Fishing Rod Hook



Storage Bins (S/M/L)



Single Hook



Extruded Door Handle

Design & Install Information

Our team's philosophy is to provide on-going complimentary guided training every step of the way. Your designers and installers will have unlimited access to our training programs and dealer platform, along with access to our customer success team for the following:

Designing Videos



Product Overview
Sales Training
Marketing Tools
3D Software Design Training
Installation Training

Installation Videos



Playlist – Quick Guide

1. Wall Creating Basic
2. Wall Creating Advanced; Webinar
3. Designing with ¼" Variances
4. Designing with 1" + Variances
5. Tall Modules; Build
6. Wall Modules; Build
7. Modules and Parts; Webinar
8. Color, Profiles, and Finishes

Advanced videos are available on our dealer portal.

1. Overview (1Vid)
2. What to Expect–Receiving (2Vids)
3. Pre-Check (6Vids)
4. Arriving and Staging (1Vid)
5. Tall Modules (8Vids)
6. Wall Modules (8Vids)
7. Closet Parts (8Vids)
8. Drawer Box Install (9Vids)
9. Cabinet Door Install (1Vid)
10. Closet Accessories (3Vids)
11. Closet Lighting (1Vid)
12. Extra Installation (2Vids)
13. Securing Modules to Wall (2Vids)
14. Removing Labels (1Vid)

ORDER PROCESS

One-Stop-Shop

Upon receiving an order, it enters our production queue, where each item is meticulously custom-produced by our team. We do not maintain inventory for standard-sized core items. The final packaged pallet includes, but is not limited to; custom-produced materials, door and drawer profiles, drawer boxes, cut-to-size closet rods, requested Hafele accessories, and all necessary hardware in individualized boxes, per space of the home ordered. The pallet arrives at our Authorized Dealer facility fully prepared for installation.

PALLET & PACKAGING



Each pallet is typically constructed to be between 8 to 10 feet long and 4 feet wide, with a height ranging from 1 to 3 feet. The weight of each pallet varies, typically between 1000 lbs. to a maximum estimated weight of 3500 lbs.

To ensure secure transport, we meticulously layer a foam barrier between each product layer to prevent movement and chipping.

Hardware and consumable items are packaged together in boxes and labeled according to the allocated space within an order. In instances where multiple spaces are accommodated on a single pallet, each space is packaged individually for added organization and protection.

Furthermore, we construct a barrier around the pallet acting as another line of defense while in transport.

Product Care

Clean with warm water, a clean rag or microfiber cloth, a soft sponge or soft brush. Use normal domestic cleaners or soaps that have no abrasive ingredients.

Then wipe with fresh water, removing all traces of the cleaning agent, to prevent streaks forming. Dry the surface with a clean, absorbent cloth or paper towels.

Avoid harsh household cleaners and abrasives.

The following cleaning agents should not be used under any circumstances:

Scouring
and
abrasive
agents.

Polish,
washing
powder,
furniture
cleaner,
bleach.

Detergents
with strong
acids and
acidic salts.

Steam
cleaning
equipment.

Warranty

Limited Lifetime Warranty

Our core products include a limited lifetime residential warranty and limited one-year non-residential warranty. Perfect Fit Closets warrants that the core products you purchased will be free from defects in material for the normal lifecycle of the products when used for single-family residential use, and or for one year when used for non-residential or commercial use. This limited warranty extends only to the original end user of the Products, and is not transferable. Each warranty claim will be reviewed case per case.

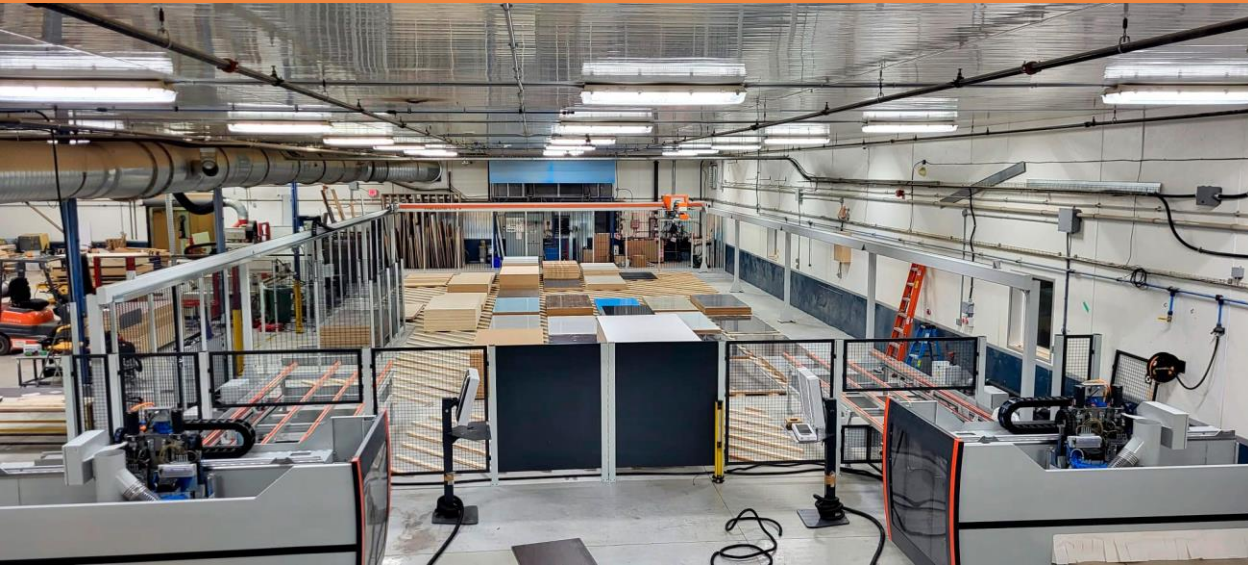

Perfect Fit
CLOSETS

